

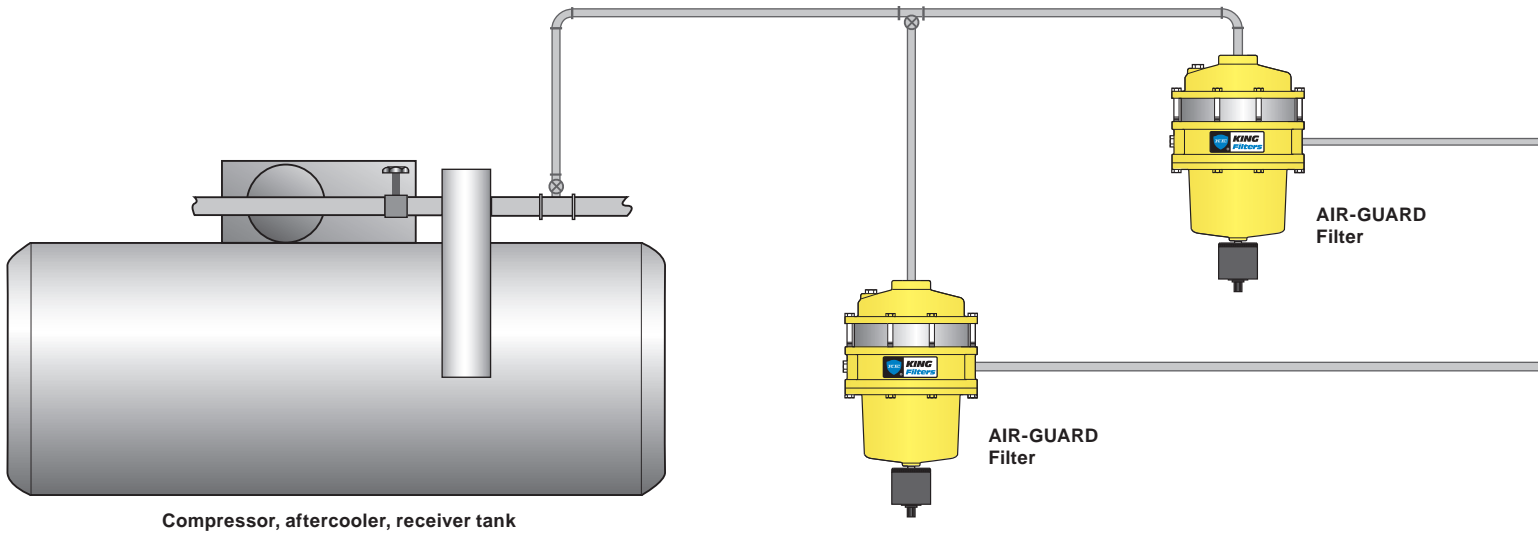

Compressed Air Filters



Ultra clean compressed air for packaging, fluidics,
laboratory, and instrumentation.



Compressed Air Filtration

End-Use Filters

Filtering the entire compressed air system at one central location does not generally provide sufficient cleaning for all end-use applications. Moreover, most compressed air piping contains some amount of rust, scale, and condensed liquids. Water vapor that may be present in warm air will tend to condense into liquid when the air cools. A compressed air filter installed just upstream of the end-use is generally the most efficient means of ensuring clean, dry air. These end-use filters can provide clean air to meet individual process requirements. A coalescing filter should be specified due to its long service life where liquid contaminants may be encountered. You should not undersize a compressed air filter. Exceeding the listed flow rate of the filter will have a proportionate decrease in the service life of the cartridge elements. Frequent cartridge replacement necessitated by under sizing an application significantly increases maintenance costs. Maximum efficiency is generally obtained between 15%–100% of the maximum rating.

Vapor and Condensation

Many types of pneumatic equipment and processes use compressed air that must be clean, dry, and oil-free. This requires the removal of liquids, aerosols, dust, and solid particulates from the airstream. Generally, only condensed liquids need to be removed. Visible fog or mist is actually composed of condensed liquid droplets. These are easily removed by using a coalescing

compressed air filter at the end-use point. Vapor is liquid in evaporated form. In this gaseous state, the liquid vapor will be invisible. Oil and water vapor are commonly present in compressed air systems. If either type of vapor must be removed, a compressed air dryer must be used. Desiccant dryers, for instance, use media that attracts the vapor molecules through a process called "adsorption".

KING Ultra-C Filters

The preferred choice for high efficiency compressed air filtration, KING Ultra-C Filters utilize a two stage design with a color indicating cartridge. These filters deliver extremely clean air for fluidic systems, critical instrumentation, packaging, paint, and coatings systems. The primary first stage element effectively removes not only solid particulate but also the extremely small aerosols of water and oil present in compressed air systems. A second "polisher" cartridge element guards against any carryover of contaminants and helps deliver even cleaner air output from the filter.

KING Ultra-C filters are available in three configurations to suit the specific application. All are based on the high efficiency coalescing action Ultra-C cartridge elements which remove oil, water, and particulate from the air stream. A compact single stage model doesn't skimp on performance while offering a small footprint. The standard two stage color-change model incorporates a color change feature to signal the need for cartridge

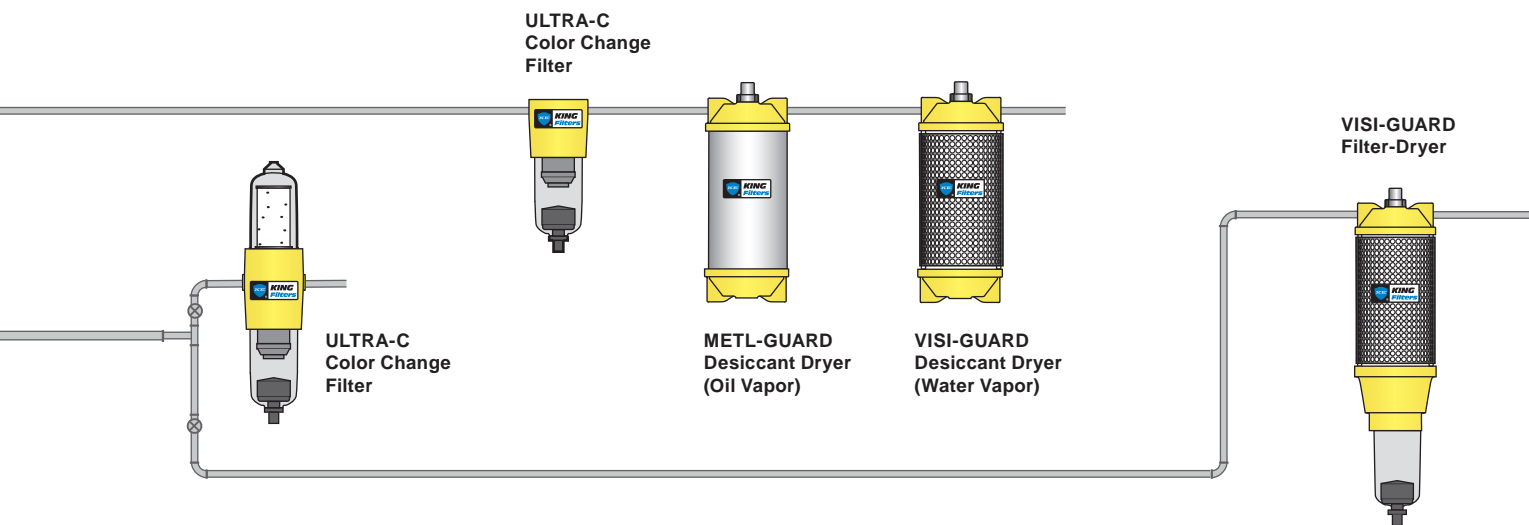

replacement. A combination filter-regulator-gauge comprises the Ultra-C Air Control Station. Each is offered with an automatic drain sump to reduce maintenance and assure continuous dry compressed air.

KING Air Guard Filters

Larger capacity flow rates and more durable construction mark our KING Air Guard line of compressed air filters. As with all KING filters, they deliver extremely clean air for fluidic systems, critical instrumentation, packaging, paint, and coatings systems. Models rated for 60 scfm and up incorporate right angle inlet/outlet porting for optimal air line piping arrangement.

Warranty

All King Engineering products are guaranteed to be free from defects in material and workmanship for one year from the date of purchase. Any product or part found to be defective, under normal use within one year of purchase, will be repaired or replaced at no charge if returned to the company at Ann Arbor, MI within ten days of discovery of the defect. No other warranties, whether express, implied or statutory, including the warranties of fitness for a particular purpose or merchantability, are given by this agreement.

The exclusive remedy for nonconformity of these goods shall be repair and replacement of the nonconforming goods or parts.

Seller shall not be liable for consequential damages resulting from breach of this agreement. The term "consequential damages" shall include but not be limited to damage to all machines, equipment and goods other than the goods sold hereby, interruption of production, loss of profits, delays of any kind, administrative expense, and overhead.

Certain products listed are protected by one or more of the following patents: U.S. PAT. 4,462,258; 4,454,760; 3,161,051 PAT. Canada 1964

Table of Contents

Ultra-C, 20 scfm	4-5
Air-Guard, 60-100 scfm	6-7
Aerosol Filter and Aerosol Strainer	8
Visi-Guard Dryer	9
Compressed Air Filter Installation—Best Practices	10
Cartridge Sets and Ratings	11
Industries Served	12



8019 Ohio River Blvd
PO Box 305
Newell WV 26050 U.S.A.

304-387-1200
855-367-2494 toll free
304-387-4417 fax

www.kingfilters.com



KING Ultra-C U203

20 scfm

KING U203 Ultra-C Filter provides high efficiency air line filtration that's competitively priced for applications demanding ultra clean compressed air for packaging, paint/coating systems, machine tools, and pneumatic instrumentation. The high efficiency two-stage filter uses a self-draining coalescing element to remove large amounts of solid and liquid contaminants from the airline. The U203 design incorporates a color indicating visible top element that slowly changes red to signal the need for replacement.

Model No.	U203 (w/ auto drain), U202 (w/ manual drain)
Rated Flow	20 scfm @ 100 psig; 566 l/min @ 7 Kg/cm ² ; 34 m ³ /hr @ 7 bar
Connections	1/2" NPT
Max. Pressure	150 psi
Filter Type	dual cartridge coalescing w/ color change indicating
Efficiency	99.98% @ 0.1 micron



Two-Stage Filtration

- Protects against carryover
- Increases cleaning capacity
- Extends service life

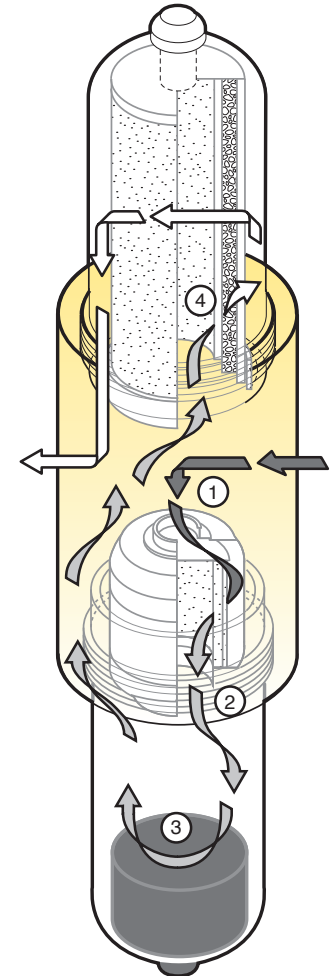

Multiple-Stage Process

1. Air enters first stage SCRUBBER coalescing element
2. Nozzle-shaped exit of cartridge directs airflow downward
3. 180° reversal slows air velocity within sump
4. Air enters POLISHER to remove final traces of sub-micron aerosols

KING Ultra-C U201

20 scfm

KING U201 Ultra-C Filter, our lowest price coalescing filter, doesn't skimp on performance. It has a single stage element intended for final cleaning of air at point of use. It also excels as a pre-filter for compressed air dryers with its energy conserving automatic sump drain with intermittent action that diverts liquid contaminants from the air stream. The compact U201 is built on a cast aluminum housing combined with a transparent polycarbonate sump.



Model No.	U201 (w/ auto drain), U200 (w/ manual drain)
Rated Flow	20 scfm @ 100 psig; 566 l/min @ 7 Kg/cm ² ; 34 m ³ /hr @ 7 bar
Connections	1/2" NPT
Max. Pressure	150 psi
Filter Type	single coalescing cartridge
Efficiency	99.9% @ 0.1 micron



KING Ultra-C U205

20 scfm

KING Model U205 Air Control Station is based on the KING Ultra C Filter combined with a high accuracy pressure regulator. The high efficiency 20 scfm two stage filter uses a self-draining coalescing element to remove large amounts of solid and liquid contaminants from the airline. This version of the station also includes a dial pressure gauge. Perfect for protecting air operated components and instrumentation since most compressed air systems contain solid and liquid contaminants that affect performance and increase wear on equipment.

Model No.	U205 (w/ auto drain), U206 (w/ manual drain)
Rated Flow	20 scfm @ 100 psig; 566 l/min @ 7 Kg/cm ² ; 34 m ³ /hr @ 7 bar
Connections	1/2" NPT
Max. Pressure	150 psi/Regulator 0–125 psi adjustment range
Filter Type	dual cartridge coalescing w/ color change indicating
Efficiency	99.98% @ 0.1 micron

Type 52SSAR Filter-Regulator, features a compact 316 stainless steel housing and filter element (5 micron). It is designed for a wide variety of environments where corrosion resistance and rugged construction is essential. An auto drain sump ensures discharge of water, oil and other contaminants. The regulator operates in pressures up to 150 psi (10.3 bar). Shown with optional gauge.



BELLOFRAM Regulators, general purpose and subminiature models from our affiliate division (Marsh Bellofram). They offer precision control, high accuracy and maximum stability for air pressure regulation.





KING Air-Guard Bronze Filter is distinguished by its extremely rugged cast bronze housing and sump. Intended for environments that demand the unique aspects of bronze, this highly efficient filter offers a durable alternative when aluminum or plastics are not desirable*. Dual cartridges (scrubber & polisher) guard against any carryover of contaminants even when the elements approach the end of their service life. Automatic drip leg drain (9313-24T) ensures discharge of liquid contaminants and override feature allows manual actuation.

Model No.	9313-24T (w/ auto drain), 9313-24 (w/ manual drain)
Rated Flow	20 scfm @ 100 psig; 566 l/min @ 7 Kg/cm ² ; 34 m ³ /hr @ 7 bar
Connections	1/2" NPT
Max. Pressure	150 psi
Filter Type	dual cartridge coalescing elements
Efficiency	99.98% @ 0.1 micron

*Drip leg drain has aluminum cap and housing.



KING Air-Guard Bronze

20 scfm

KING Air-Guard Model 9460 compressed air filter with its 60 scfm flow rating is intended for main supply line applications where pipe scale, residual oil aerosols, and condensation can degrade air quality. The long service life afforded by the dual cartridge design ensures high performance filtration. Air-Guard Model 9460 is supplied with KING Type 750/800 element set that includes coalescing scrubber and adsorptive polisher cartridges. (Type 300/300 element set is an optional selection—see cartridge descriptions on page 11.)

Model No.	9460-3T (w/ auto drain), 9460-3 (w/ manual drain)
Rated Flow	60 scfm @ 100 psig; 1699 l/min @ 7 Kg/cm ² ; 102 m ³ /hr @ 7 bar
Connections	1" NPT
Max. Pressure	150 psi
Filter Type	dual cartridge coalescing elements
Efficiency	99.998% @ 0.1 micron

KING Air-Guard 9460

60 scfm



KING Air-Guard Model 2479 compressed air filter with its 80 scfm flow rating ensures high performance filtration afforded by its dual stage cartridge design. This larger capacity filter is designed to remove particulate dust, water/oil aerosols, and condensation often present in main compressed air supply lines. Air-Guard Model 2479 is supplied with KING Type 750/800 element set that includes coalescing scrubber and adsorptive polisher cartridges. (Type 300/300 element set is an optional selection—see cartridge descriptions on page 11.)

Model No.	2479-1T (w/ auto drain), 2479-1 (w/ manual drain)
Rated Flow	80 scfm @ 100 psig; 2265 l/min @ 7 Kg/cm ² ; 136 m ³ /hr @ 7 bar
Connections	1" NPT
Max. Pressure	150 psi
Filter Type	dual cartridge coalescing elements
Efficiency	99.998% @ 0.1 micron



KING Air-Guard 2479

80 scfm



KING Air-Guard 2260

100 scfm

KING Air-Guard Model 2260 compressed air filter with its 100 scfm flow rating offers high efficiency coalescing action to deliver clean, dry, and oil-free air. Its higher flow capacity makes it perfect for installation in main distribution air piping to remove residual oil, condensed water, and abrasive particulates. The long service life afforded by the dual cartridge design ensures high performance filtration. Air-Guard Model 2260 is supplied with KING Type 750/800 element set that includes coalescing scrubber and adsorptive polisher cartridges. (Type 300/300 element set is an optional selection—see cartridge descriptions on page 11.)

Model No.	2260-1T (w/ auto drain), 2260-1 (w/ manual drain)
Rated Flow	100 scfm @ 100 psig; 2832 l/min @ 7 Kg/cm ² ; 170 m ³ /hr @ 7 bar
Connections	1" NPT
Max. Pressure	150 psi
Filter Type	dual cartridge coalescing elements
Efficiency	99.998% @ 0.1 micron



KING Aerosol Filter 2160, designed for final clean-up of compressed air, utilizes media with a natural affinity for fine droplets (aerosols) of oils and water. The adsorptive element removes even the smallest sub-micron particles and contaminants to deliver clean, dry, and oil-free air. Recommended for end use applications having higher air consumption such as blow molding, packaging, and paint/coatings systems. (Aerosol filter should be used in conjunction with an upstream coalescing compressed air filter such as the KING Air-Guard 2260.)

Model No.	2160
Rated Flow	100 scfm @ 100 psig; 2832 l/min @ 7 Kg/cm ² ; 170 m ³ /hr @ 7 bar
Connections	1" NPT
Max. Pressure	150 psi
Filter Type	single adsorptive element
Efficiency	98.0% @ 0.1 micron

KING Aerosol Filter

100 scfm



KING Aerosol Strainer 2201 is designed for low-volume point of use. This disposable strainer can remove even sub-micron sized contaminants often present in compressed air. Choose this compact filter for low volume discharge such as air guns, air cylinders or use it as disposable inline protection. (Aerosol strainer should be used in conjunction with upstream coalescing compressed air filters.)



KING Aerosol Strainer

2 scfm

Model No.	2201-14-12-1
Connections	1/4" NPT; male inlet/female outlet
Model No.	2201-32-12-1
Connections	1/4" NPT; female inlet/male outlet
Model No.	2201-34-12-1
Connections	1/4" NPT; female inlet/female outlet
Rated Flow	2 scfm @ 100 psig; 566 l/min @ 7 Kg/cm ² ; 3 m ³ /hr @ 7 bar
Max. Pressure	125 psi
Filter Type	single adsorptive element
Efficiency	97.0% @ 0.3 micron

KING Visi-Guard 4532 Filter Dryer, combination coalescing filter and desiccant dryer, provides a complete solution for critical end use applications. It incorporates a first stage submicron filter element and second stage vapor removal (oil or water) for applications such as product packaging or even precision laboratory equipment and instrumentation. Desiccant selection determines application: AC-1 or MS-2 reduces oil vapor to ≤ 0.5 ppm (w/w); water vapor reducing desiccants allow for dew points as low as $-100^{\circ}\text{F}/-73^{\circ}\text{C}$ (MS-1) or $-50^{\circ}\text{F}/-45^{\circ}\text{C}$ (SG-1).

Model No.	4532-23T (w/ auto drain), 4532-23 (w/ manual drain)
Rated Flow	12 scfm @ 100 psig; 340 l/min @ 7 Kg/cm ² ; 20 m ³ /hr @ 7 bar
Connections	1/2" NPT
Max. Pressure	150 psi
Filter Type	coalescing element, 2nd stage desiccant bed
Efficiency	99.9% @ 0.1 micron, vapor content ≤ 0.5 ppm



KING Visi-Guard 4532

12 scfm

KING Visi-Guard 1716

12 scfm



KING Visi-Guard 1716 Dryer utilizes a desiccant bed to remove water or oil vapor for critical compressed air needs. (Choice of desiccant media selection determines application.) The Visi-Guard acrylic chamber is especially suited for SG-1 indicating silica gel that changes from blue to pink when the air supply approaches 20% RH. Properly maintained, the dryer can reduce dew point to $-50^{\circ}\text{F}/-45^{\circ}\text{C}$. (Alternate AC-1 desiccant can reduce oil vapor content to less than 0.5 PPM w/w.)

Model No.	1716-10
Rated Flow	12 scfm @ 100 psig; 340 l/min @ 7 Kg/cm ² ; 20 m ³ /hr @ 7 bar
Connections	1/2" NPT
Max. Pressure	150 psi
Filter Type	desiccant bed
Efficiency	vapor content ≤ 0.5 ppm



Compressed Air Filter Installation— Best Practices

Air Flow Bypass

Applications that demand continuous air flow should be provided with a piping bypass. This allows for filter cartridge replacement without service interruption. Shut off valves quickly permit temporary re-routing of the air flow.

For extremely critical air quality applications, another filter should be present in the bypass as well.

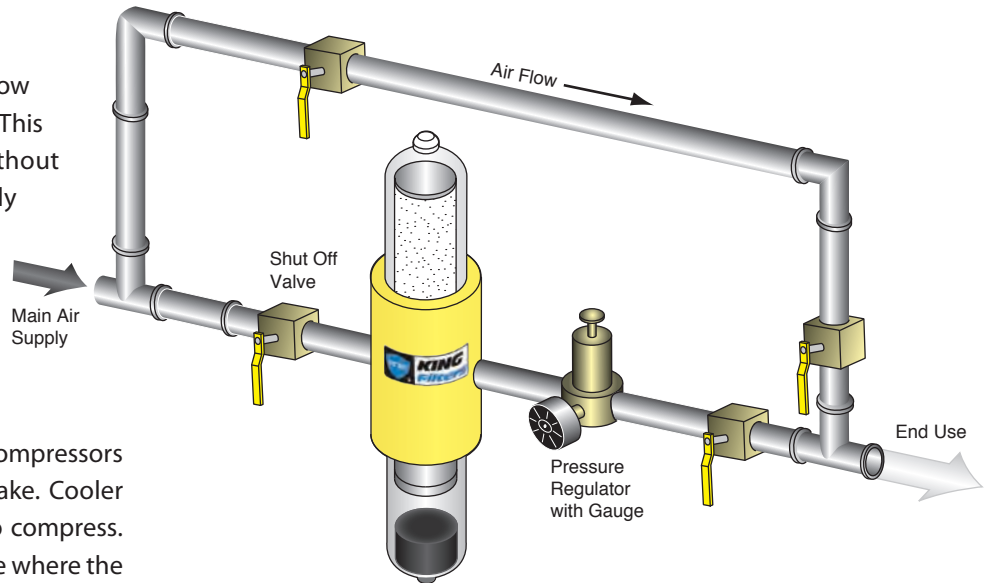

Intake Air Temperature

Reduce energy consumption by supplying compressors with outside air ducted directly to the intake. Cooler air is denser and will require less energy to compress. Simply introducing outside air into the space where the compressor resides will not realize these savings because of the ambient heat it will absorb.

System Pressure

Insufficient air flow or pressure is often caused by the compressed air system piping. Incorrect pipe size may cause pressure drops.

Try to reduce the number of sharp right angle bends in piping and ensure adequate size of the main piping run in the facility. When pressure is set relatively high in the attempt to deliver adequate air flow to the end use points, compressors increase their energy demand and air consumption may needlessly rise at discharge points.

Distribution Piping

Air distribution piping should be large enough in diameter to minimize pressure drop. A loop system is generally recommended, with all piping sloped away from the compressor to accessible drop legs and drain points. Piping from the header to points-of-use should connect to the top or side of the header to avoid being filled with condensate.

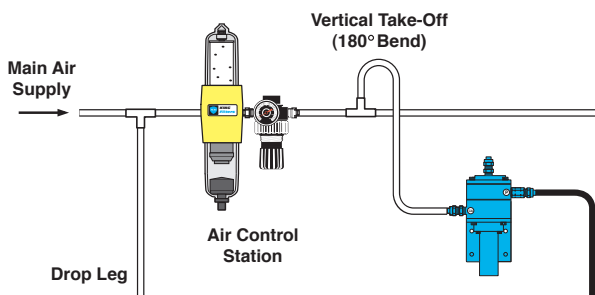

Maximum Recommended Air Flow (scfm) for ANSI Schedule 40 Pipe

Pressure (psig)	1/4"	1/2"	1"	1-1/2"
10	1.7	7.7	21	64
20	3.0	13.0	35	110
40	5.5	23.0	62	200
60	8.0	34.0	93	290
80	10.5	44.0	120	380
100	13.0	54.0	150	470
150	20.0	80.0	220	680
200	26.0	108.0	290	910

Pressure drop of 10% of applied pressure per 100 linear feet for 1/4" and 1/2" pipe sizes; pressure drop of 5% of applied pressure per 100 linear feet for 1" and 1-1/2" pipe sizes. Maximum recommended air flow (scfm) for ANSI standard weight schedule 40 pipe.





















Cartridge Sets and Ratings

KING compressed air filter cartridges are available in different grades. Recommended options are listed below. Our Ultra-C and Type 750/800 cartridges meet the particulate requirements of ISO 8573-1* Quality Class 1 specification for compressed air. Type 300/300 cartridge sets provide lower pressure drop in applications and meet ISO 8573-1 Quality Class 3 specification for particulate removal.

KING filter cartridge elements provide equal efficiency regardless of flow rate. Filtering efficiency does not diminish during the life of the cartridges so you can be assured of consistent performance and air quality.

Without question, most compressed air systems contain solid and liquid contaminants that affect performance and increase wear on equipment. Precision pneumatic instrumentation including KING-GAGE tank level gauging systems require clean, dry, and oil-free compressed air for trouble free operation.

**ISO 8573-1:2010 specifies purity classes of compressed air with respect to particles, water and oil independent of the location in the compressed air system at which the air is specified or measured. ISO Class noted is for particulate removal only.*

20 scfm cartridge sets			
0.1 micron U3002, U3003	99.998%	 Ultra-C scrubber	 Ultra-C polisher
0.1 micron A22-11-6-5 cartridge set	99.998%	 Type 750 scrubber	 Type 800 polisher
2.0 micron A22-11-1-1 cartridge set	98.0%	 Type 300 scrubber	 Type 300 polisher
60 scfm cartridge sets			
0.1 micron 22-31-6-5 cartridge set	99.998%	 Type 750 scrubber	 Type 800 polisher
2.0 micron 22-31-1-1 cartridge set	98.0%	 Type 300 scrubber	 Type 300 polisher
80 scfm cartridge sets			
0.1 micron 22-41-6-5 cartridge set	99.998%	 Type 750 scrubber	 Type 800 polisher
2.0 micron 22-41-1-1 cartridge set	98.0%	 Type 300 scrubber	 Type 300 polisher
100 scfm cartridge sets			
0.1 micron A22-51-6-5 cartridge set	99.998%	 Type 750 scrubber	 Type 800 polisher
2.0 micron A22-51-1-1 cartridge set	98.0%	 Type 300 scrubber	 Type 300 polisher
12 scfm cartridge & desiccant			
0.1 micron 9318-80	99.9%	 Type 750 scrubber	 See desiccant selections below:
1730	SG-1 desiccant	Water vapor (-50°F / -45°C dew point)	Service Temp. 100°F / 38°C
1730-5	MS-1 desiccant	Water vapor (-100°F / -73°C dew point)	Service Temp. 200°F / 93°C
1730-4	AC-1 desiccant	Oil vapor (≤ 0.5 ppm w/w)	Service Temp. 120°F / 49°C

Industries Served

Founded in 1937, King Engineering supplies the food, dairy, beverage, personal care, pharmaceutical, industrial, and chemical sectors as well as specialized applications for the marine industry. Recognized as a leader in the design and manufacture of compressed air filtration, King Engineering continues its commitment to engineering, innovation, and product development.

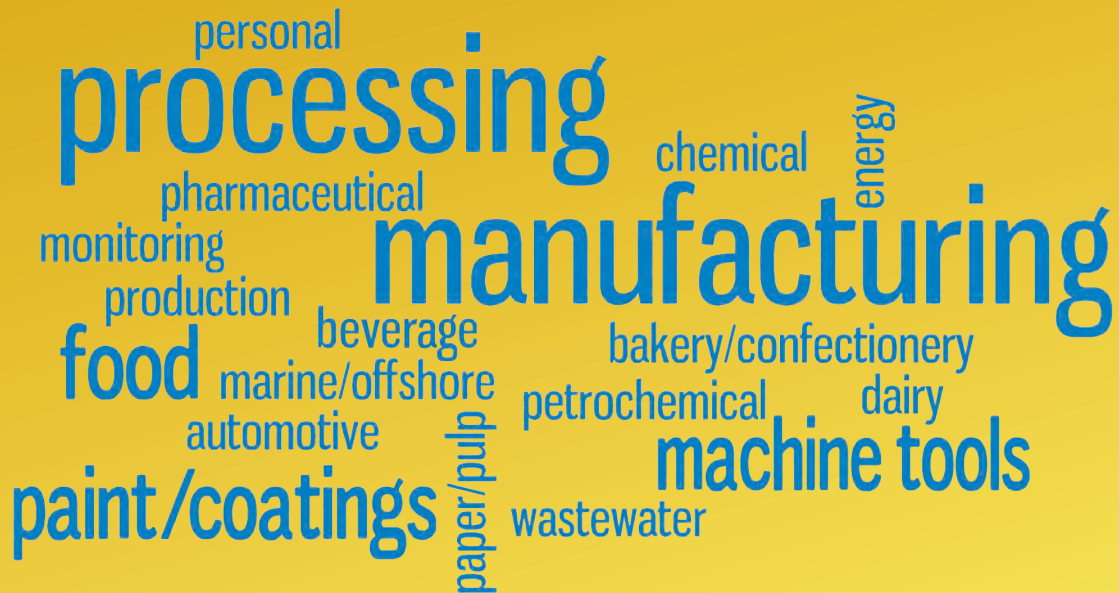

KING ENGINEERING
8019 Ohio River Blvd
State Route 2, Box 305
Newell WV 26050 U.S.A.

304-387-1200
855-367-2494 toll free
304-387-4417 fax



www.kingfilters.com