

LevelPRO™ SP

Multiple Tank Level Processor

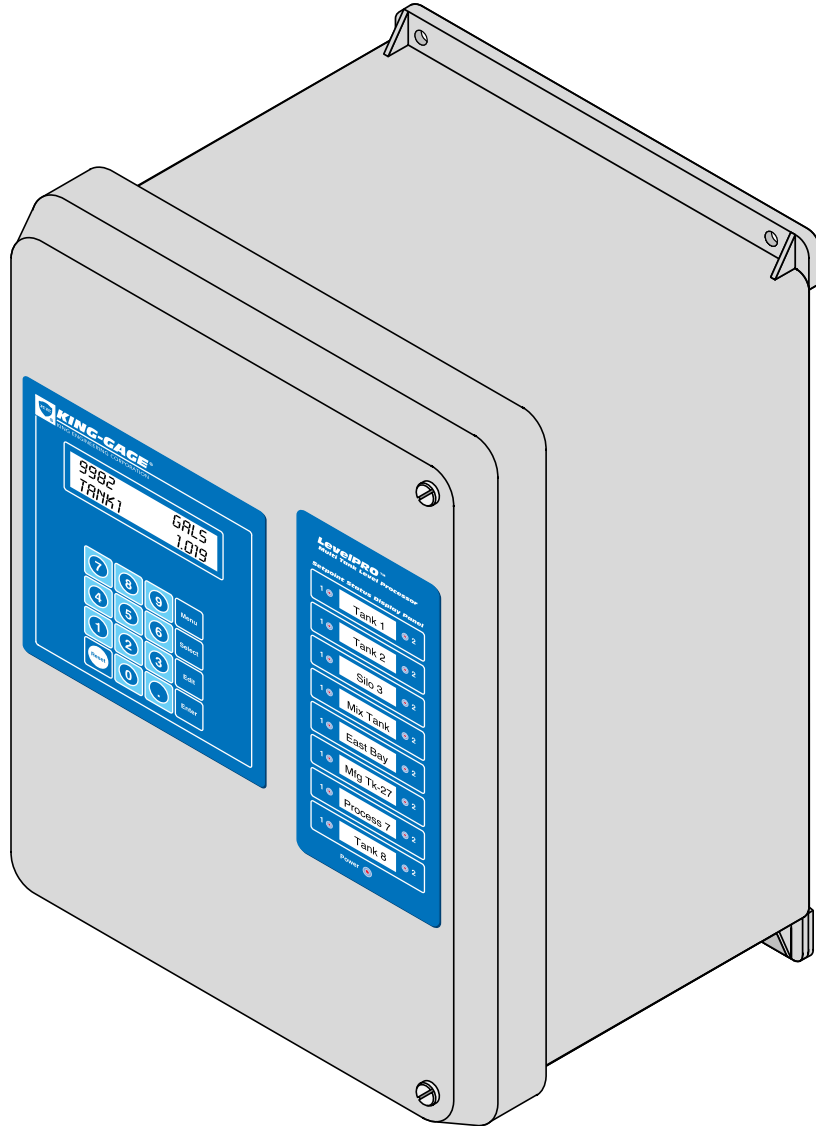

Model 5252-21-1x, 5252-21-2x Installation and Operation Manual

The information contained in this manual was accurate at the time of release. Specifications are subject to change without notice.

Warranty - All King Engineering products are guaranteed to be free from defects in material and workmanship for one year from the date of purchase. Any product or part found to be defective under normal use within one year of purchase will be repaired or replaced at no charge if returned to the company at Ann Arbor, Michigan within ten days of discovery of the defect. No other warranties, whether expressed, implied or statutory, including the warranties of fitness for a particular purpose or merchantability, are given by this agreement. The exclusive remedy for nonconformity of these goods shall be repair and/or replacement of the nonconforming goods or parts.

Seller will not be liable for consequential damages resulting from breach of this agreement. The term "consequential damages" shall include but shall not be limited to damage to all machines, equipment and goods other than the goods sold hereby, interruption of production, loss of profits, delays of any kind, administrative expense and overhead.

Revisions:

(A) August, 1997 – Original Release

© 1997 King Engineering Corporation. All rights reserved.

® KING-GAGE and the KE emblem are registered trademarks and LevelPRO is a trademark of King Engineering Corporation, Ann Arbor, Michigan, U.S.A.

Specifications subject to change without notice.

Table of Contents

Tank Level Status Display and User Keypad page 4

Mounting Dimensions — Model 5252-21-1x, 5252-21-2x page 5

Installation Requirements page 8

Setpoint Relay (SPDT) Connections page 9

Application Datapack (SRAM) page 10

Using the Operator Interface Keypad page 11

Entering Level Setpoints page 12

Troubleshooting Checklist page 13

Network Communications (RS-485) page 14

Communications Specifications and Protocol page 15

LevelPRO SP Model No. Designation

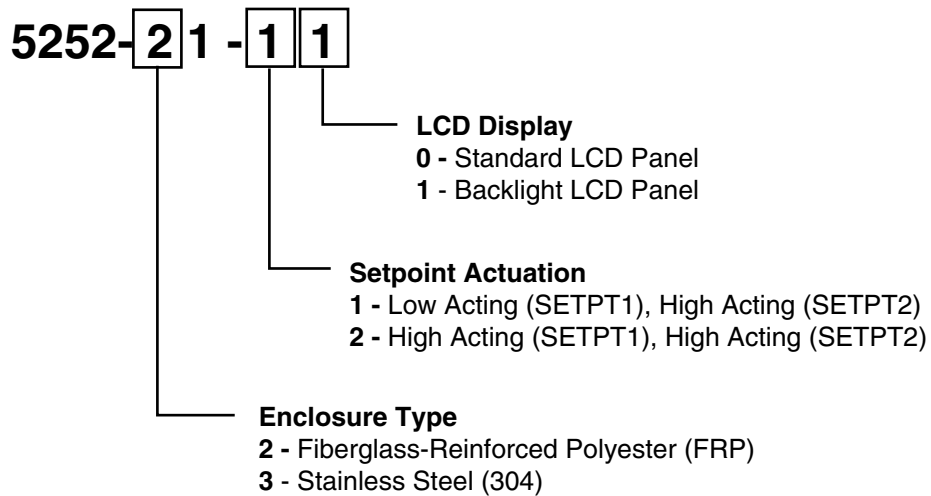

KING-GAGE LevelPRO™ SP Multiple Tank Level Processor

LevelPRO Processors provide continuous measurement of liquid inventory in storage or processing tanks. They calculate level on the basis of hydrostatic pressure created by liquid depth in the tank. This pressure is the result of both depth and density (specific gravity). Specific gravity can be entered into the LevelPRO system through the user keypad.

The LevelPRO Tank Processor expresses output directly in engineering units. The processor references a capacity profile to correlate transmitter output to actual tank geometry. The processor then formats the resulting value directly as the total weight or volume of liquid in the tank. As an operator interface, the keypad provides access to function selection and data entry. Unlike digital panel meters, there are no user conversion factors involved or scaling points to enter. All application details have been factory programmed into SRAM.

Tank Level Status Display

A two line alphanumeric LCD readout provides tank level indication including the unit of measurement (gals, lbs, ltrs, kgs). The second status line identifies the tank by name up to 10 characters/spaces in length. Level can be represented by up to an 8-digit value to allow direct weight indication for even extremely large tanks (see detail below).

Function/Numeric Keypad

LevelPRO SP Tank Level Processor incorporates a membrane keypad for number entry and function selection. This keypad is used to enter the setpoint actuation values for simple on/off control operations.



Detail - Operator Interface Keypad

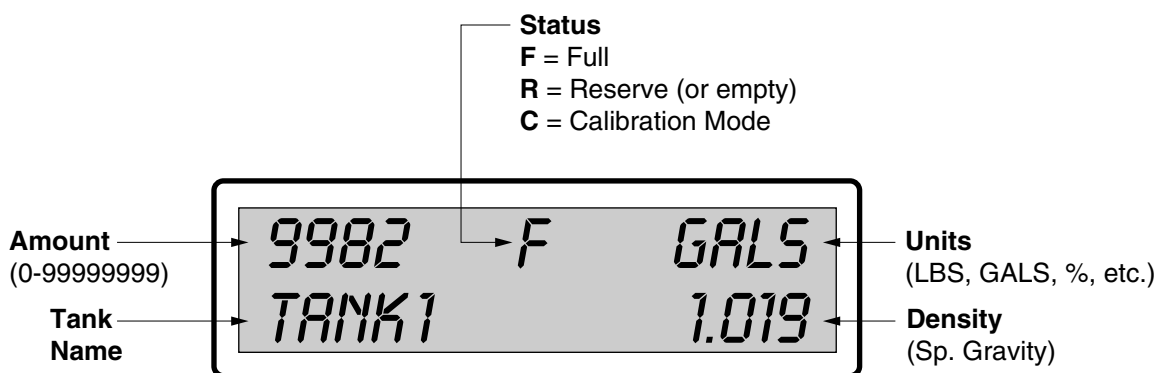

Detail - Tank Level Status Display

SPECIFICATIONS

Power Requirements

115 Vac, 50/60 Hz., 1.5 Amp, source grounded. Power consumption rated 100 watts max.

Signal input

4-20 mAdc

Input Channels

Eight (8) two wire channel inputs

Memory

SRAM, 8k x 8, 100 ns

Input Impedance

120 Ohm nominal resistance (2.4 Vdc drop @ 20 mAdc)

Power Output

24 Vdc excitation available at +Signal terminal, 0.5 Amp max.

Readout

alphanumeric 0.3173 in. (8 mm) 16-character x 2-line LCD; numeric 8-digit; 7-digit resolution (0-99999999 maximum).

Setpoint Relays

(16) sixteen independent user setpoints; (2) setpoints per tank channel; SPDT (form-C) relays, maximum 3.0 A @ 115 Vac. Rated for minimum 100,000 cycle/life at rated load.; continuously adjustable over full input range. Front panel LED status indicator gives visual confirmation when set-point value has been exceeded.

Resolution

0.024% FS (± 0.004 mA)

Accuracy

± 0.048% FS (± 0.024% FS typical)

Keypad

Membrane numeric keypad, five (5) function keys, positive tactile response

Temperature Range

30°F to 120°F / -1°C to 49°C (operating environment)

Housing

Fiberglass-reinforced polyester (FRP) enclosure; U.L. listed (U.L. 508) types 3, 3R, 3S, 4, 4X, and 12. Lexan front panel on hinged cover with dual latching screws.

**Mounting Dimensions -
Models 5252-21-1x, 5252-21-2x**

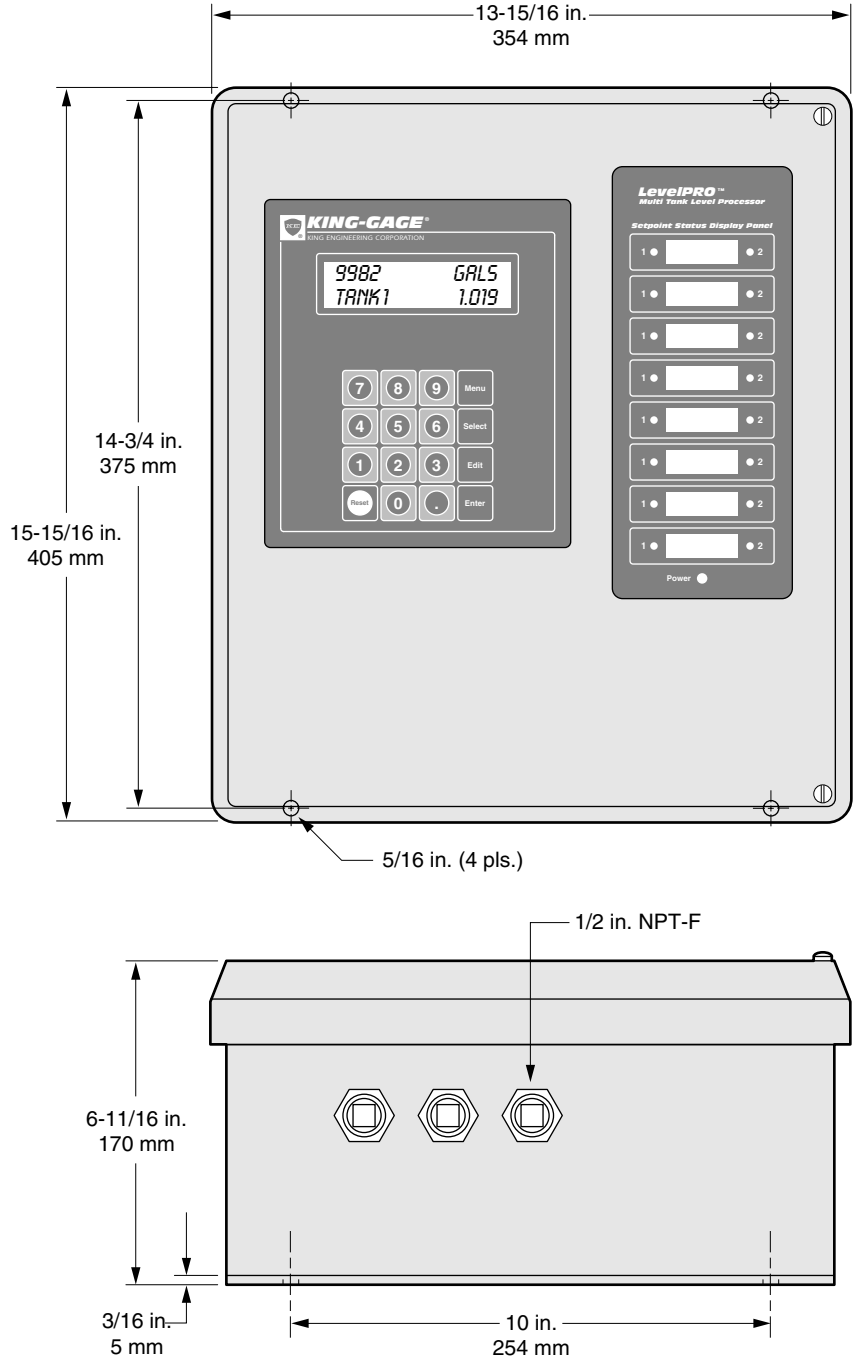

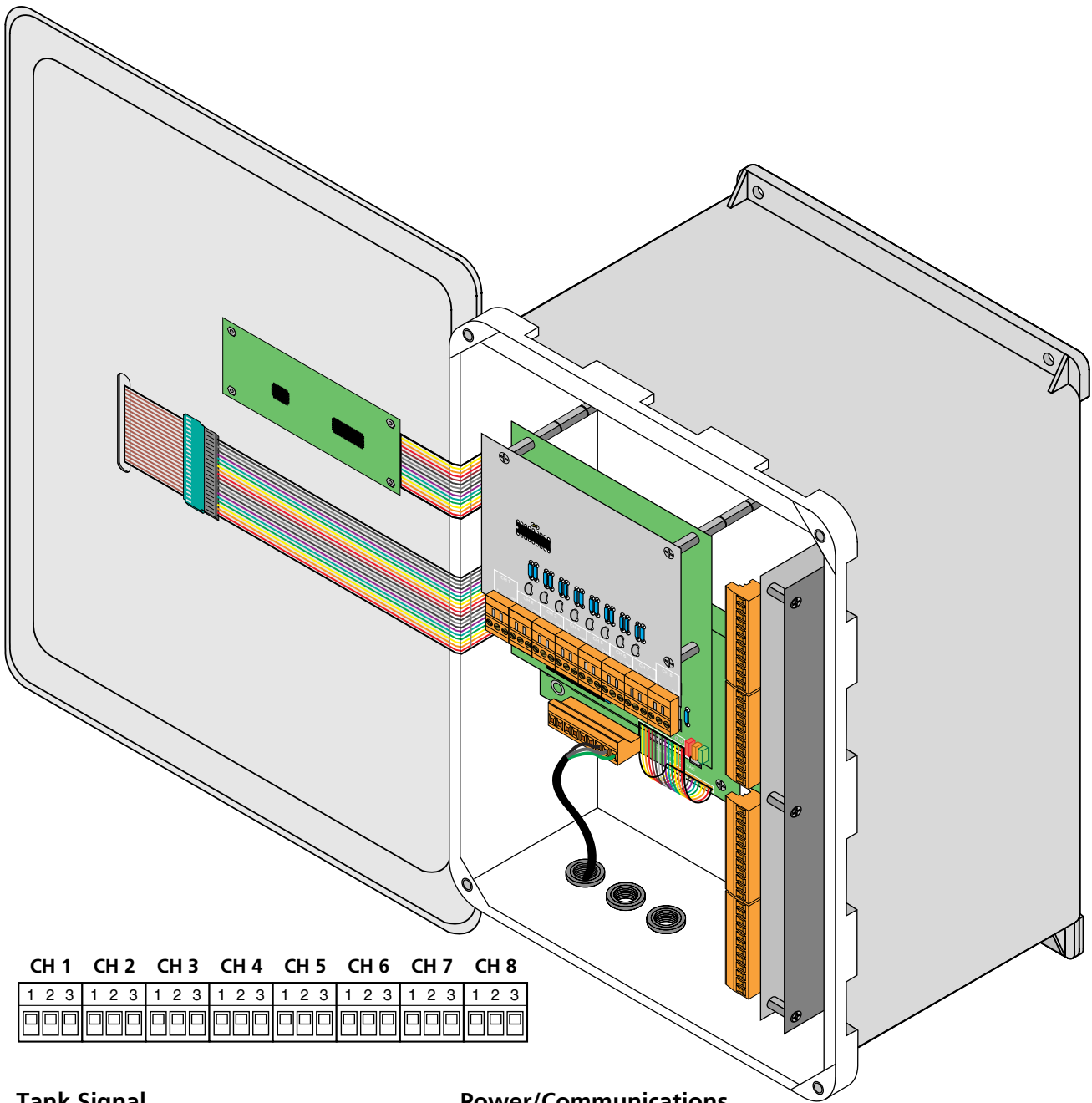

CH 1			CH 2			CH 3			CH 4			CH 5			CH 6			CH 7			CH 8					
1	2	3	1	2	3	1	2	3	1	2	3	1	2	3	1	2	3	1	2	3	1	2	3	1	2	3
□	□	□	□	□	□	□	□	□	□	□	□	□	□	□	□	□	□	□	□	□	□	□	□	□	□	□

Tank Signal Connector

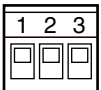

- 1 - + 4-20 mA Signal
- 2 - - 4-20 mA Signal
- 3 - Option

LevelPro SP Specifications

- Signal Input:** 4-20mA_{dc}
- Input Impedance:** 120 Ohms nominal, (2.4V_{dc} @ 20 mA)
- Output Excitation:** 24 V_{dc} (+Signal)
- Power Requirement:** 115 Vac, 50/60 Hz., 1.5 Amp

Power/Communications Connector

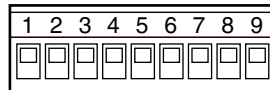

- 1 - N/C
 - 2 - N/C
 - 3 - A
 - 4 - B
 - 5 - Shield
 - 6 - N/C
 - 7 - HOT
 - 8 - NEU
 - 9 - GND
- RS485/422 (pins 3, 4, 5)
- 115 Vac (pins 7, 8, 9)

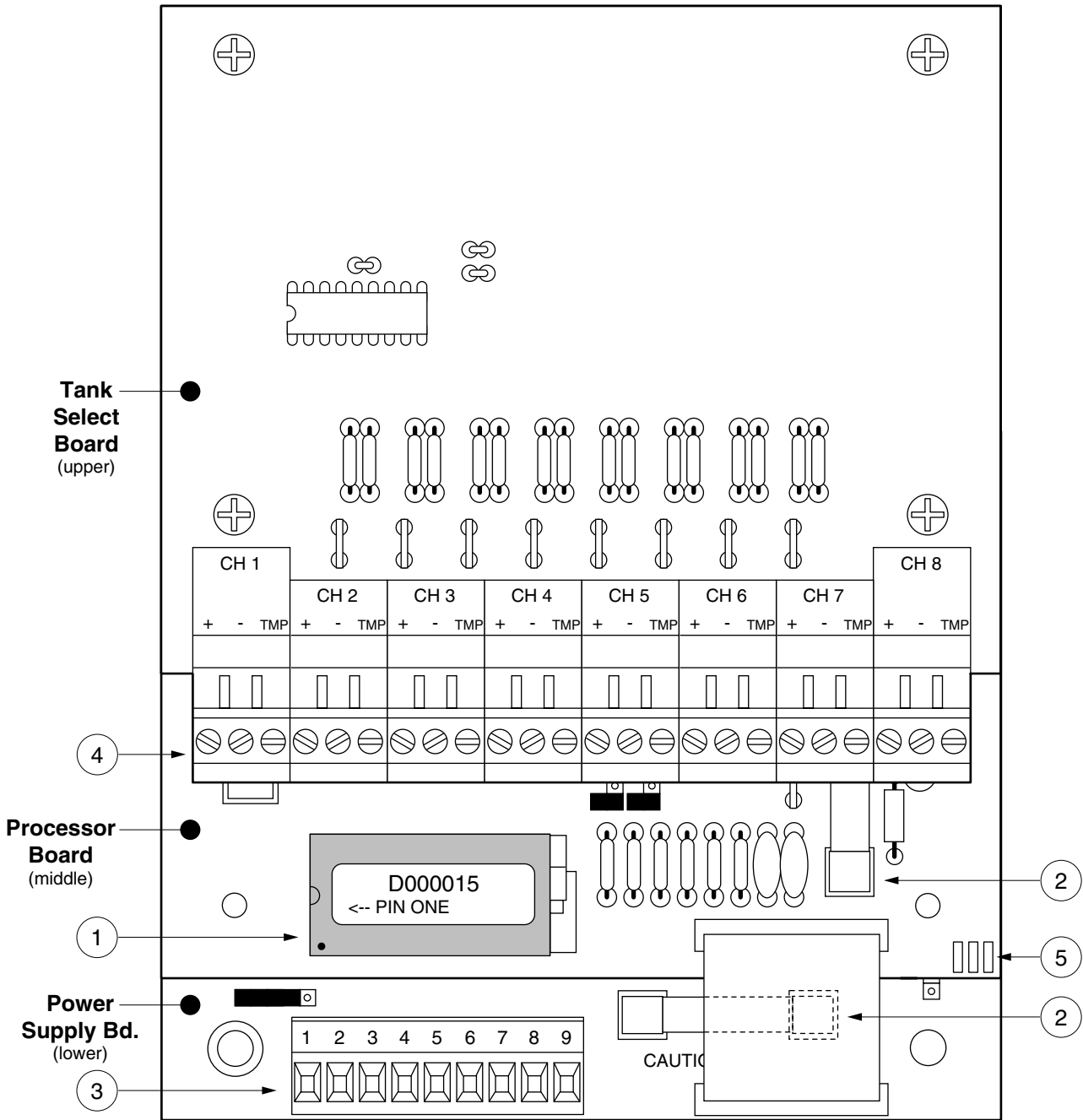

Internal User Details:

1. Datapack (SRAM)
2. 1/2 Amp Fuse - 120/250 Volt Fast-Blo
Order No. 7469-21-0 (5-pack)
3. Terminal, Power/Communication
4. Terminal, Signal Input
5. Status LEDs

Status LED Indicators

(not all versions include this feature)

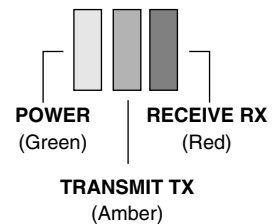

Installation Requirements

Mounting -

The LevelPRO Processor may be mounted at the tank, or up to several thousand feet away. It is important to find a mounting location that affords some degree of protection for the unit. Do not locate where sub-freezing temperatures may be encountered.

Enclosure should be mounted in an upright position to a wall or other structural member. Cabling access ports are 1/2" NPT and intended for conduit or water-tight cable connectors. Keep unused connections sealed to maintain enclosure integrity. When locating enclosure, maintain adequate clearance for access to bottom connections.

Signal Input and Electrical Connections

We recommend completing the transmitter input signal (4-20 mA) connections prior to AC power, when practical. Use approved 3-conductor, source grounded power cable for 115 Vac connections.

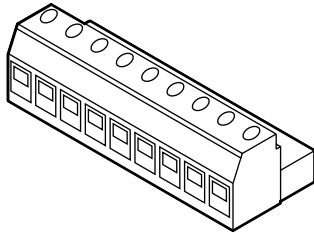

Detail - Plug-in terminal connector for AC Power & Communications

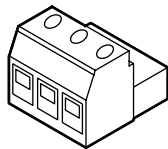

Detail - Plug-in terminal connector for signal input (4-20 mAdc)

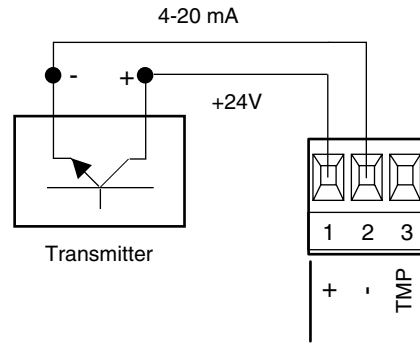

Detail - 24 Vdc Output at Signal Terminals from onboard power supply

LevelPRO SP Power Output (24 Vdc)

The LevelPRO SP supplies 24 Vdc excitation for the transmitters and signal loop. If the signal loop is connected to other receivers (I/O card, panel meter, indicator), make certain that power output is bypassed at these other devices when used in conjunction with the LevelPRO SP.

Important! Disable or bypass Vdc power output from any other device wired into the signal loop from the transmitter.

Recommended Signal Cabling

20 AWG shielded cable (Belden 9320 or equivalent).

Avoid cable placement along multi-phase power lines or equipment that generates strong EMI/RFI fields.

Setpoint Relay Connections

The LevelPRO SP provides two (2) setpoint SPDT relays per tank channel. Each plug-in 12-terminal connector accommodates two channels and is installed in one of four banks (Bank A, Bank B, Bank C, Bank D) as illustrated below.

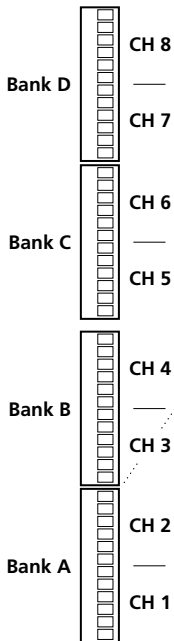
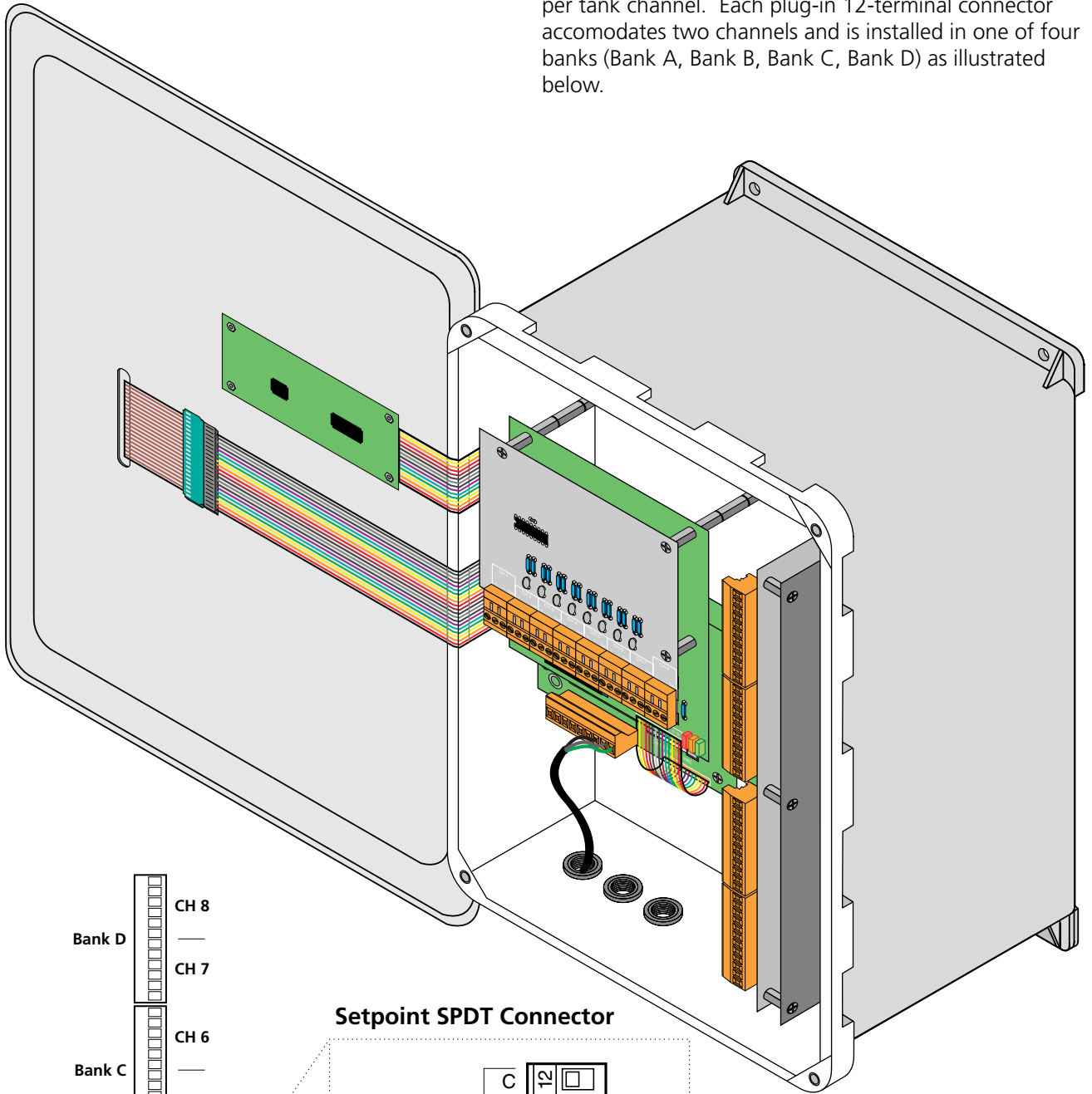

Setpoint SPDT Connector

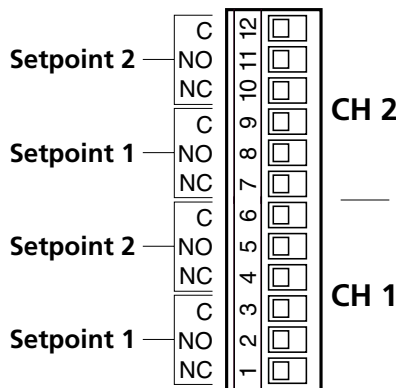

Application Datapack (SRAM)

The LevelPRO Tank Processor expresses output directly in engineering units. The processor references a capacity profile to correlate transmitter output to actual tank geometry. The processor then displays the resulting value directly as the total weight or volume of liquid in the tank. All application details are factory programmed into SRAM.

Referred to as the Application Datapack, this SRAM memory contains a default liquid density value, readout units factor and tank name. In addition to battery backup, critical data such as the capacity profile are not user-addressable to prevent any possible corruption of the original factory programming.

Editing Specific Gravity Value: This avoids the need to re-range the level transmitter when the tank is used for more than one liquid product density. The operator interface keypad permits direct editing of the current specific gravity corresponding to the tank contents (see page 11). Another method uses the external communications link and ASCII command protocol (see Addendum), to change specific gravity value from a remote terminal or PLC.

Installing Updated Datapack (SRAM)

Non-addressable application parameters (i.e., tank name, network polling address, tank capacity profile) require updated datapack programmed at the factory. Use caution when accessing the datapack — internal circuitry and electrical connections should not be exposed to moisture. Turn off power to unit prior to handling internal components.

Turn off power or open the enclosure and disconnect the plug-in terminal connector. Datapack (SRAM) is readily accessible at the lower

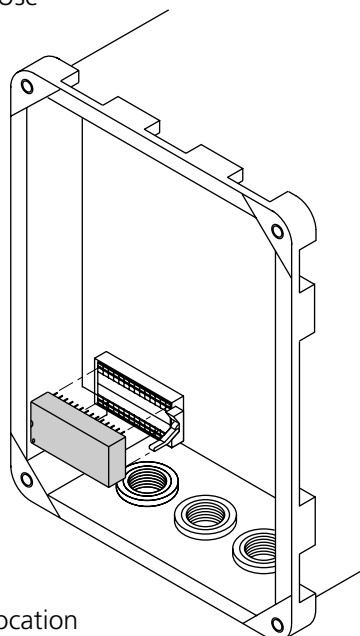

Detail - Datapack location

left hand corner of the lower circuit card.

- A. To remove datapack, lift up on locking lever (see illustration) on zero insertion force (ZIF) socket. Remove datapack.
- B. To install datapack, insert datapack carefully into socket. Push locking lever down and forward to lock datapack within socket.

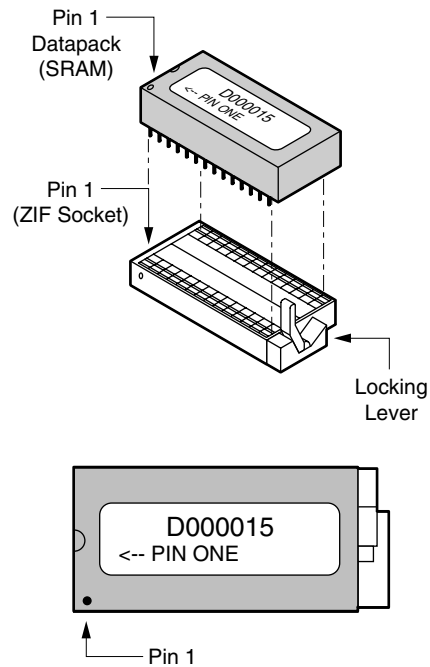

Important! Datapack (SRAM) must be oriented so that PIN 1 lines up with socket. The <-- symbol on label designates PIN 1 side. Refer to illustration above.

LevelPRO Keypad Operator Interface

Data entry (specific gravity values) or alternate readout unit selections can be performed through the keypad at the LevelPRO Multiple Tank processor.

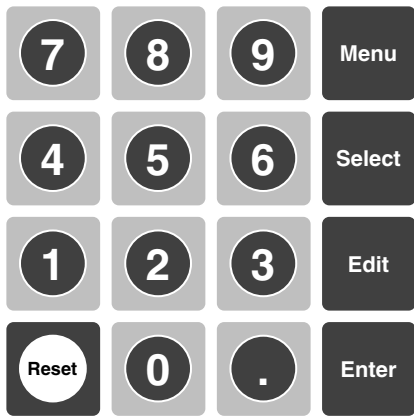

Detail - LevelPRO™ Keypad

Scanning Tank Channels

To view each tank sequentially by its channel assignment (1-8) merely press **SELECT**. Repeat to view the next channel and so on through all the active channels.

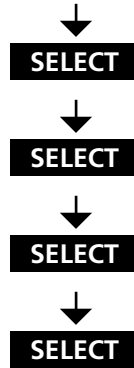

19990 TANK ST1	GALS 1.000
855 TANK ST2	GALS 1.032
11120 TANK ST3	GALS 1.012
100 TANK ST4	GALS 1.028
35870 TANK ST5	GALS 1.008

Direct Access Tank Selection

For direct or random access, enter the channel number (1-8) on the keypad. While viewing a selected tank level, press **5** to go directly to the tank level display corresponding to channel #5. Next, press **8** to view tank level display corresponding to channel #8.

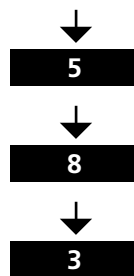

19990 TANK ST1	GALS 1.000
35870 TANK ST5	GALS 1.008
61565 TANK 8	GALS 1.023
11120 TANK ST3	GALS 1.012

Menu Display Modes

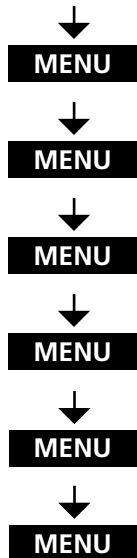

6055 TANK 1	GALS 1.000
SP.GRAVITY TANK 1	1.000
UNITS TANK 1	GALS
CALIBRATION OFF	
500 TANK 1	GALS SETPT1
5700 TANK 1	GALS SETPT2
6055 TANK 1	GALS 1.000

Specific Gravity Editing

Specific gravity can be entered directly through the user keypad. Press **MENU** to access the "SP.GRAVITY" value and then **EDIT**. Now merely enter the 4-digit number directly (the decimal point is a fixed place holder). Press **ENTER** to accept the new value and return to the tank level display.

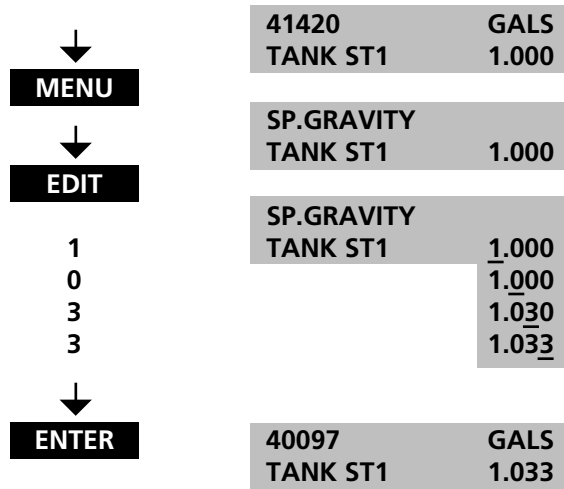

Selecting Display Units

To change the readout units, use the keypad at the Main Processor. Press the **MENU** key. "SP.GRAVITY" appears on the display. Press the MENU key again for the "UNITS" display. Then use the **SELECT** key to sequence through the readout units selections. When the desired readout unit is displayed, press the **ENTER** key to accept the selection.

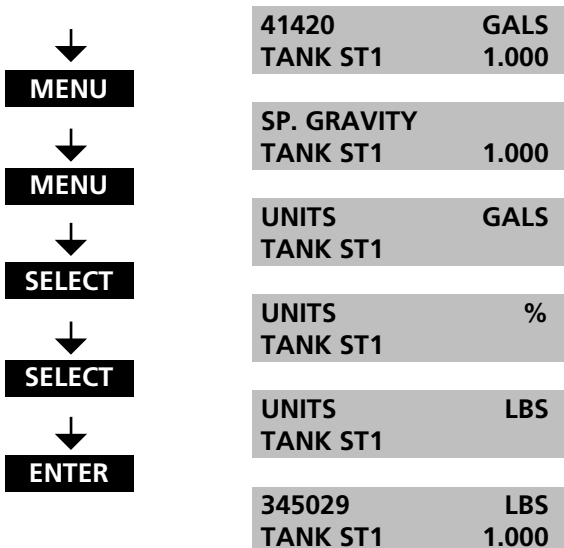

Entering Level Setpoints

Changing setpoints is as easy as entering the desired tank level either in % or directly in the units of measurement (gallons, lbs, etc). To enter a new setpoint value, select the corresponding tank channel so that it is displayed on the readout.

Next, press MENU to cycle through the display modes until SETPT1 or SETPT2 appears.

Tank Setpoint Editing

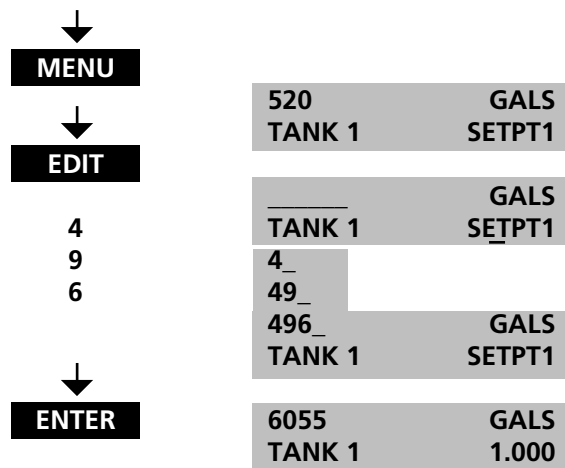

Tank Setpoint Editing

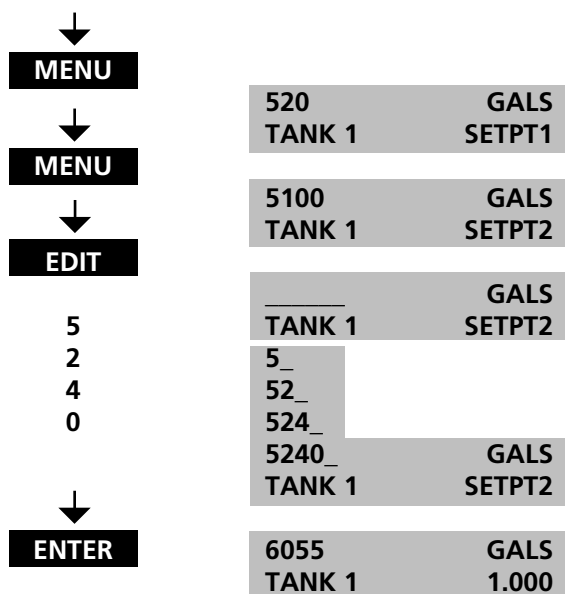

Troubleshooting Checklist

Certain problems experienced during initial system installation and start-up may result from incomplete connections.

No Display

Unit does not appear to be functioning and nothing appears on the LCD panel.

- Press "Reset" button on keypad.
- Make certain that Tank Processor is connected to 115 Vac power source.
- Check internal fuse(s) on internal board set of Tank Processor and replace if necessary.

Low Reading

Level value being displayed is inaccurately low, or does not rise when level increases.

- Press "Reset" button on keypad.
- Check sensor/transmitter output (if necessary, check zero and span settings).
- Signal connections are reversed at the tank processor input terminals or were reversed at the transmitter terminals.
- Resistive load on signal loop exceeds capacity of transmitter at the supplied 24 Vdc excitation from the Tank Processor.
- If Datapack (SRAM) is missing or has been removed, unit will default to "calibration" mode. Unit will only display A/D counts (0-4096) and the "C" status indicator will appear in the top line.

High Reading

Level value being displayed is inaccurately high.

- Check sensor/transmitter output (if necessary, check zero and span settings).
- Check that tank vent is open. (Rapid fill rate may sometimes exceed venting capacity creating internal pressure in the tank.)
- Specific gravity of liquid in tank may be greater than that programmed into tank processor Datapack (PROM). Check that the specific gravity value (lower right hand corner) being displayed for that tank is correct. Use keypad to enter corrected value if necessary.

ERROR Message

The word "ERROR" appears on the display when the LevelPRO SP is turned on or Reset button is pushed.

- Loss of communication between processor board and setpoint relay board. Check ribbon cable.

LED Communications Status Indicators

These LEDs monitor the RS-485/422 interface and indicate the status of Transmit (TX) and Receive (RX) operations. Not all versions of the LevelPRO SP include these LED indicators.

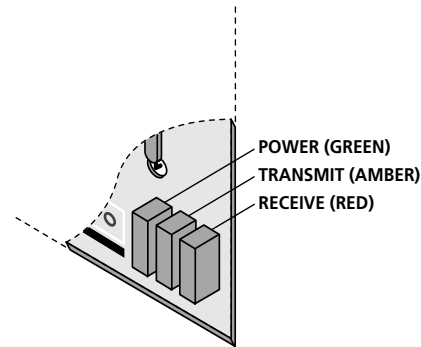

GREEN On = Power is On

GREEN Off = Power is Off

The green LED is illuminated when power is supplied to the unit. If the green LED is not lit, check that the external power supply is connected to unit. (Internal fuse may also be blown.)

The following LEDs apply only when the LevelPRO SP has been wired for communications to a PLC or computer.

AMBER On (Blinking) = Data Transmit

AMBER Off = Not Transmitting

The amber LED is illuminated during each data pulse transmission. During normal operation, the LED will be blinking on/off in combination with the red (receive) LED. If the receive (red) LED is functioning but there is no indication from the amber LED, the LevelPRO address code and requested address code may be different. (Typically, this could be the result of the wrong address code programmed into the LevelPRO or the host device.) Otherwise, unit may have an internal component failure.

RED On (Blinking) = Data Received

RED Off = No Data Received

RED Always On = RS-485 A + B Line Reversed

The red LED is illuminated in response to each data pulse received. During normal operation, the LED will be blinking on/off in combination with the amber (transmit) LED. If there is no indication from the red LED, there may be a problem with the data format from the host. If the red LED is continuously illuminated, this indicates a crossed connection between the A + B sides of the RS-485 two wire interface (try reversing the A + B connections at the LevelPRO).

Communications Interface - Network Systems

Network Communications (RS-485)

LevelPRO tank processors can provide direct ASCII communications via a two wire multi-drop network interface. Recommended communications cable is Belden 9501 (24 AWG twisted pair stranded conductors, copper drain wire, overall shielding).

Connections are provided on the plug in terminal for A, B and SH (shield). Refer to the RS-485 diagram for proper cabling connections. Up to 32 individual LevelPRO devices can be installed on a multi-drop network.

Preliminary Network Communications Troubleshooting

These are only a few possible causes of communications problems. Also, consult available reference materials for the host or receiver (i.e., PLC or PC) that is being used to communicate with the LevelPRO devices.

No Communications

Loss of communications to all devices in the network.

- Check connections at RS-485 terminals at each device. If one processor has been disconnected from the network, make certain that cabling has continuity.
- Check that power is being supplied to the LevelPRO processors. There will be no communications if individual devices suffer loss of power.

No Communications Response (Individual)

Failure of queried polling address device to respond with communications

- Check that power is supplied to the LevelPRO processor. Additionally, check internal power supply fuse, replace if necessary.
- Check communications connections at RS-485 terminals. If cable conductors have been reversed, unit will not be able to communicate. Make certain that A, B, SHD (shield) continuity has been maintained.
- Possible incorrect polling address. 3-digit ASCII address value must correspond to polling address programmed in datapack (SRAM) of LevelPRO.

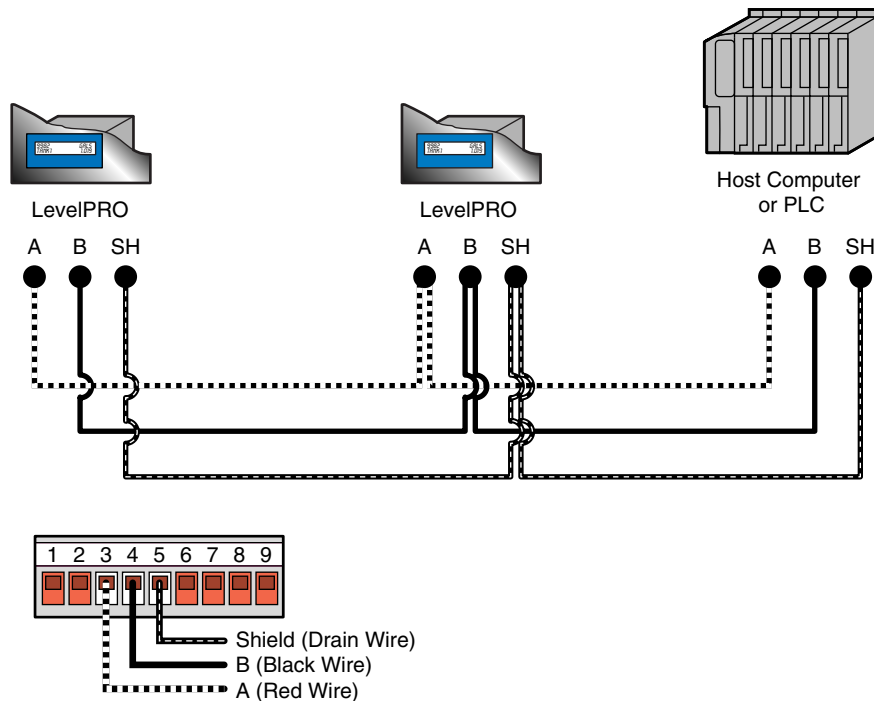

Detail - RS-485 diagram

King Bus ASCII Communications

Communications Technical Specifications:

- Two wire half-duplex with isolated ground
- Automatic signal level shifting for point-to-point (RS-422) and multi-drop (RS-485).
- ASCII character transmission formatted as (0) start bit, (8) data bits and (1) stop bit.
- Standard baud rate up to 19.2 kbps.

Host Polling Protocol

The host device must query LevelPRO processors to receive level data and/or to change specific gravity values. The query should be configured using the following ASCII code formats.

Request Level Data:

#NNN*

- # = Beginning character, first character sent (\$23 Hex)
- NNN** = 3 character ASCII polling address, 001-256
- * = Terminating character, last character sent (\$2A Hex)

Change Specific Gravity:

#NNN_S.SSS*

- # = Beginning character, first character sent (\$23 Hex)
- NNN** = 3 character ASCII polling address, 001-256
- _ = Space character (\$20 Hex)
- S.SSS** = 5 character specific gravity includes decimal (\$2E Hex) character
- * = Terminating character, last character sent (\$2A Hex)

The King Bus ASCII protocol is used by LevelPRO processors having the KINGCODE.HEX microcontroller code. These units are designated by serial numbers beginning with the letter D.

For LevelPRO processors that employ MODBUS compatible communications, refer to EX-1803-2 protocol manual. Units designated by serial numbers beginning with the letter M have the KINGMBUS microcontroller code.

LevelPRO Response Format

Communications output from individual processor in response to query by host.

31 Character Response:

NNN_S.SSS_XLLLLLLLL_UUUU_CCCC<CR><LF>

NNN = 3 character ASCII polling address, 001-256
_ = Space character (\$20 Hex)

S.SSS = 5 character specific gravity includes decimal (\$2E Hex) character
_ = Space character (\$20 Hex)

X = Status code; B (blank), F (full), R (reserve/empty), C (calibration mode)

LLLLLLLL = 8 character level value, leading zeros required if applicable

_ = Space character (\$20 Hex)

UUUU = 4 character units abbreviation/code in the form, GALS

_ = Space character (\$20 Hex)

CCCC = Check sum in ASCII representation of a 2-byte number in the form, OFE5

<CR> = Carriage return (\$0D Hex)

<LF> = Line feed (\$0A Hex)

Sample Response:

001_1.032_B00023900_GALS_04DC<CR><LF>

Checksum does not include the last space character (\$20), carriage return (\$0D), line feed (\$0A) or the checksum value itself.

The actual hex data transmission:

\$30 \$30 \$31 \$20 \$31 \$2E \$30 \$33 \$32 \$20 \$42 \$30
\$30 \$30 \$32 \$33 \$39 \$30 \$30 \$20 \$47 \$41 \$4C \$53
\$20 \$30 \$35 \$34 \$33 \$0D \$0A

(Underlined values are not added to the preceding bytes to create the checksum.)

Note:

Before January 1998, use area code 313-662-5691 or Fax 313-662-6652. The new area code of 734 will be required after June 1998.



Box 1228, Ann Arbor, Michigan 48106-1228 U.S.A.
Phone: (734) 662-5691 ■ FAX: (734) 662-6652