

LevelPRO™

Multiple Tank Level Processor

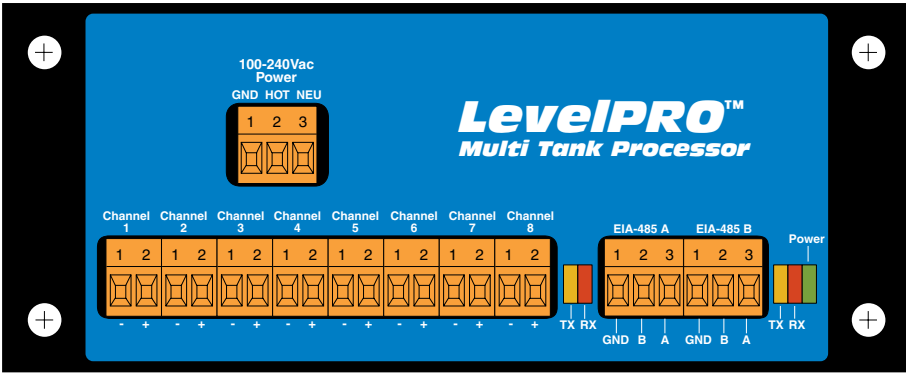

Installation and Operations Manual

Models:

- 4642-1

The information contained in this manual was accurate at the time of release. Specifications are subject to change without notice.

Warranty - All King Engineering products are guaranteed to be free from defects in material and workmanship for one year from the date of purchase. Any product or part found to be defective under normal use within one year of purchase will be repaired or replaced at no charge if returned to the company at Ann Arbor, Michigan within ten days of discovery of the defect. No other warranties, whether expressed, implied or statutory, including the warranties of fitness for a particular purpose or merchantability, are given by this agreement. The exclusive remedy for nonconformity of these goods shall be repair and/or replacement of the nonconforming goods or parts.

Seller will not be liable for consequential damages resulting from breach of this agreement. The term "consequential damages" shall include but shall not be limited to damage to all machines, equipment and goods other than the goods sold hereby, interruption of production, loss of profits, delays of any kind, administrative expense and overhead.

Revisions:

- (A) July, 2000 – Original Release (New Version)
- (B) August, 2000 – Revised page 11 and page 12
- (C) September, 2000 – Revised illustration page 6

- © 2000 King Engineering Corporation. All rights reserved.
- ® KING-GAGE and the KE emblem are registered trademarks and LevelPRO is a trademark of King Engineering Corporation, Ann Arbor, Michigan, U.S.A.

Specifications subject to change without notice.

KING-GAGE LevelPRO™ Multiple Tank Level Processor

LevelPRO Processors provide continuous measurement of liquid inventory in storage or processing tanks. They calculate level on the basis of hydrostatic pressure created by liquid depth in the tank. This pressure is the result of both depth and density (specific gravity). Specific gravity can be entered into the LevelPRO system through the user keypad.

The LevelPRO Tank Processor expresses output directly in engineering units. The processor references a capacity profile to correlate transmitter output to actual tank geometry. The processor then formats the resulting value directly as the total weight or volume of liquid in the tank.

Input Requirements

LevelPRO Tank Level Processor accepts standard proportional 4-20 mA output from the liquid level transmitter. The sensor used to detect hydrostatic pressure (created by liquid depth) can be either electronic or pneumatic. With the latter, an electronic pressure transmitter is used to convert the sensor's pneumatic signal into a 4-20 mA output. This can be done with a KING-GAGE® D/P Module or D/P Transmitter.

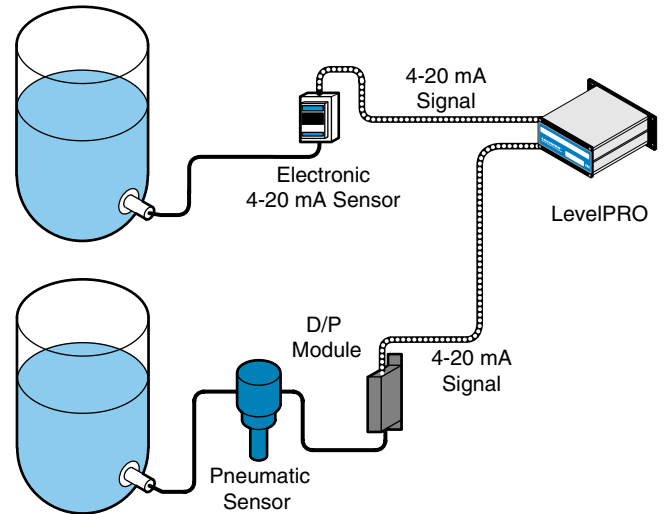

Table of Contents

Input Requirements page 4

Specifications — Model 4642-1 page 5

24 Vdc Output - Enable/Disable Transmitter Excitation page 9

Datapack iButton (installation) page 10

Troubleshooting Checklist page 11

Network Communications (RS-485) page 12

Addendum; Communications Specifications page 13

Specifications – 4642-1

- **Power Requirements**
100-240 Vac, 50-60 Hz, 25 watts (fused internally for 2.5 A 120/250 V)
- **Temperature Range** (Environmental)
30°F to 120°F (-1°C to 49°C) operating range
- **Signal Input**
4-20 milliampere (mA)
- **Input Channels**
8 input channels; two wire 4-20 mA analog signal
- **Power Output**
24 Vdc nominal; fused @ 0.5 Amp
- **Input Impedance** (Resistance)
120 ohm nominal (2.4 Vdc drop @ 20 mA)
- **Memory**
Nonvolatile 64kbit memory iButton
- **Accuracy**
±0.048% FS (±0.024% FS, typical)
- **Resolution**
±0.024% FS maximum (±0.004 mA)
- **Communications**
Two (2) serial EIA RS-485 ports; two wire multidrop
- **Housing**
Extruded aluminum construction; surface (backplane) mount.

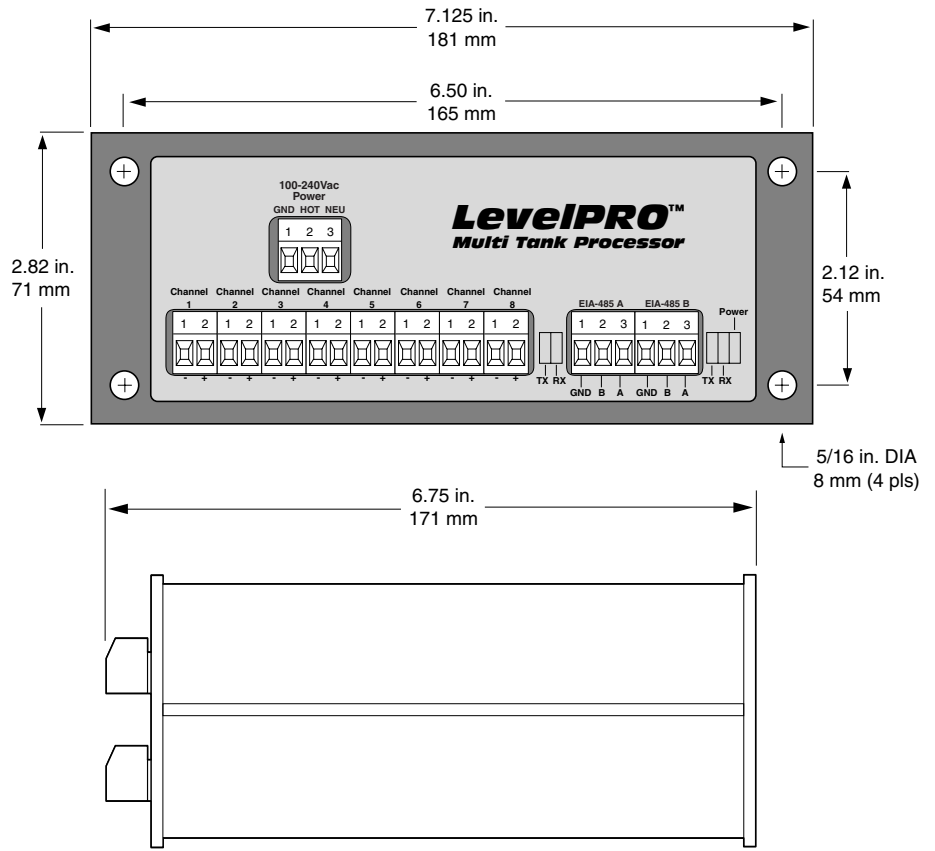

Model 4642-1

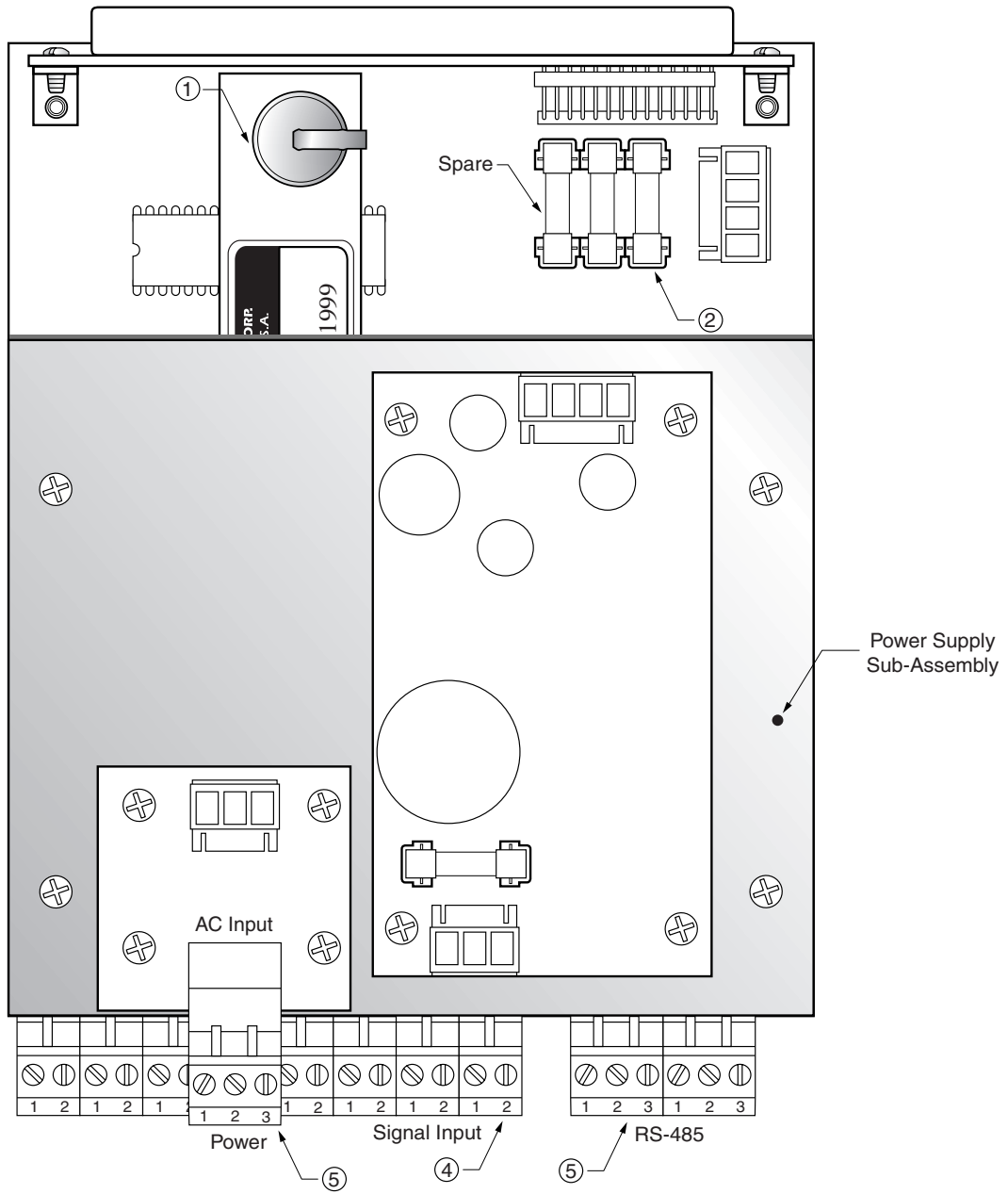

LevelPRO Processor
Internal Chassis
(Removed from Housing)

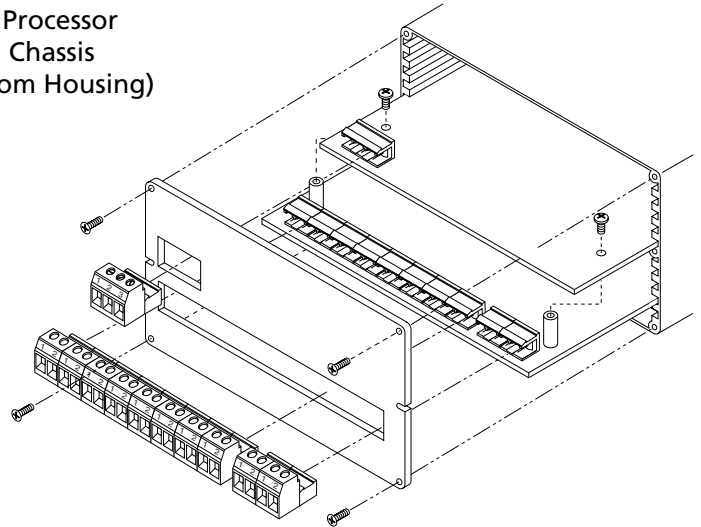

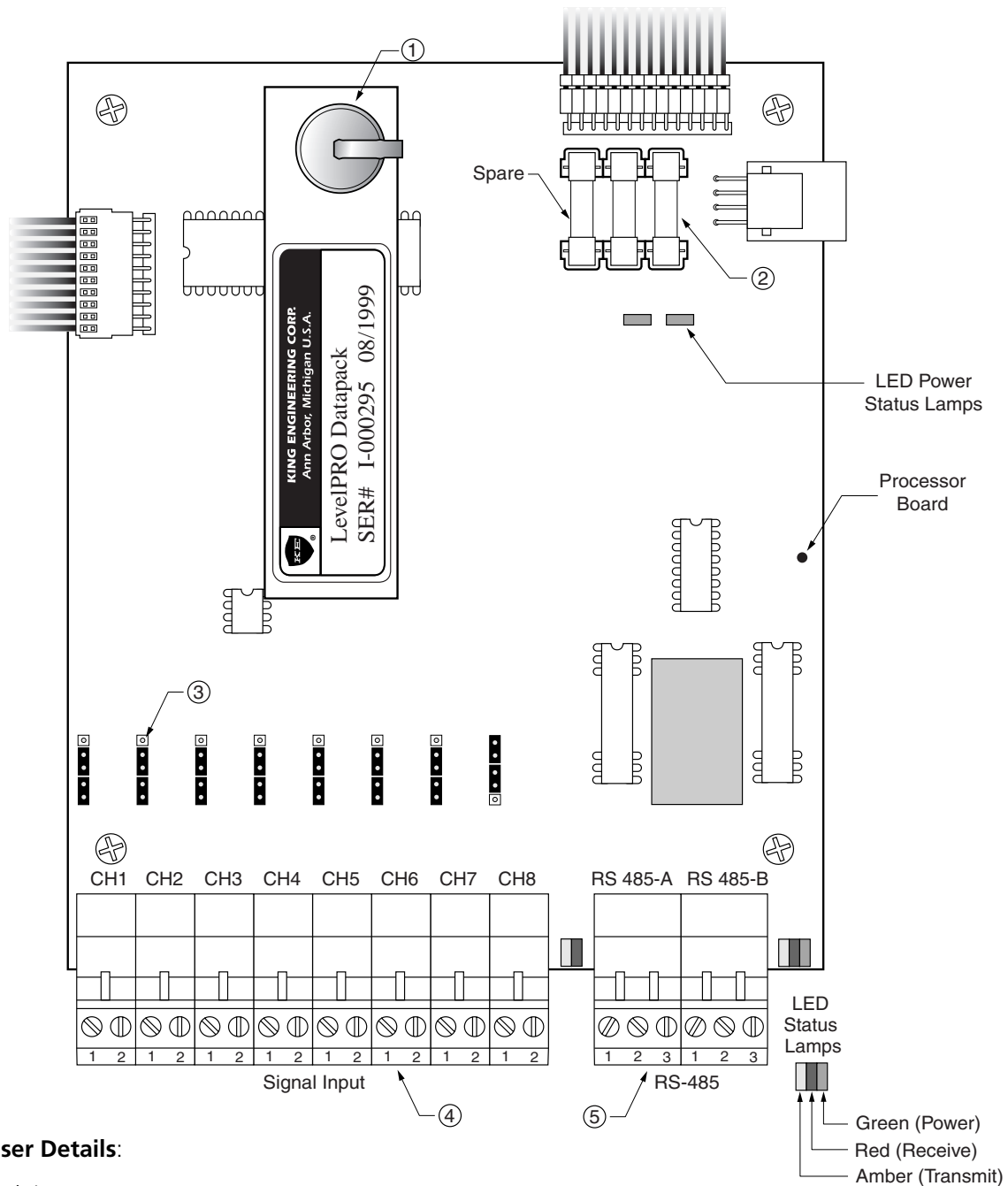

Internal User Details:

1. Datapack iButton
2. 1/2 Amp Fuse - 120/250 Volt
Fast-Blo Order No. 7469-24-0
(5-pack)
3. Shunt /Jumper ; used in pairs to
activate or bypass 24Vdc
excitation.
4. Terminal, Signal Input
5. Serial EIA – 485 communication
ports(2).
6. 100-240Vac, 50-60 Hz, Power
input.

**Input Signal
Connector**

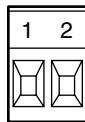

1 – Signal –
2 – Signal + (4-20 mA)

**RS – 485
Connector**

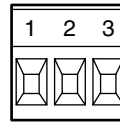

1 – GND
2 – B
3 – A } Data

**AC Input
Connector**

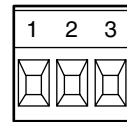

1 – GND
2 – Hot (Line)
3 – Neutral

Installation Requirements

Mounting -

The LevelPRO Processor may be mounted at the tank, or up to several thousand feet away. It is important to find a mounting location that affords some degree of protection for the unit. Do not locate where sub-freezing temperatures may be encountered.

Signal Input and Electrical Connections

We recommend completing the transmitter input signal (4-20 mA) connections prior to AC power, when practical. Use approved 3-conductor, source grounded power cable for typical 115 Vac connections.

Input Signal Connector

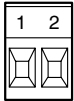

- 1 – Signal –
- 2 – Signal + (4-20 mA)

RS – 485 Connector

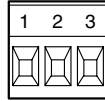

- 1 – GND
- 2 – B
- 3 – A } Data

AC Input Connector

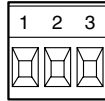

- 1 – GND
- 2 – Hot (Line)
- 3 – Neutral

Transmitter Signal Loop

Typical transmitter provides a 4-20 mA output over a dc-powered two wire current loop circuit. This normally requires at least a 24 Vdc power source to provide excitation voltage to the transmitter. The power requirements should be calculated to accommodate the total resistive load residing on the circuit (e.g., cabling impedance, input impedance of receivers, etc.). Refer to the specific load capacity specifications for the sensor or transmitter being used.

Signal Cabling

The 4-20 mA signal loop needs to be run using twisted pair (two conductor) cable. “Noise” or EMI (electromagnetic interference) does not generally create a problem since it is common to both wires in the pair and essentially cancels itself out. In most applications, non-shielded twisted pair instrumentation cable (20-22 AWG) will be suitable for the signal loop between the LevelPRO and sensor/transmitter.

Recommended Signal Cable: 20 or 22 AWG twisted pair.

NOTE: Shielded twisted pair cable may be used for extremely noisy environments where strong EMI/RFI fields exist. It is critical that shielded cabling be properly earth grounded on one end only. This will guard against the shield from becoming a conductor if improper electrical wiring exists elsewhere in the system or facility. The shield should be grounded to the GND terminal of the earth grounded Vac power connection. (Power supplied to the LevelPRO processor must be 3-line source with earth ground.)

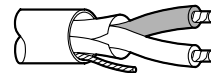

Shield (or drain wire)
Connected to ground
at one end only!

24 Vdc Output (Transmitter Excitation)

The LevelPRO tank processor incorporates an internal 24 Vdc supply that can be used to power the signal loop. A pair of shunt/jumpers for each input channel are used to enable or disable this voltage supply across the signal input terminals. The unit is shipped from the factory with the jumpers installed in the ENABLED (B) position to provide 24 Vdc across signal input terminals #1 and #2. If you are using an external power supply, move the jumpers to the DISABLED (A) position. Refer to the illustration showing the location of the shunt/jumpers.

NOTE: When configured for external power (DISABLED), all of the affected (-) terminals are connected together in the LevelPRO. The transmitters must be connected to the (+) side of the loop and the (-) side must return directly to the power supply. Be certain to check that the external power supply is "floating" such that the (-) terminal is not directly tied to an earth ground.

IMPORTANT! Use caution when connecting signals to analog input cards in computers or PLCs. Many of these are "single ended" in that they tie the signal grounds of many different devices together. This can result in unpredictable current paths and unstable signals.

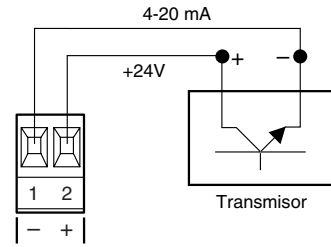

Detail - Onboard 24 Vdc Output

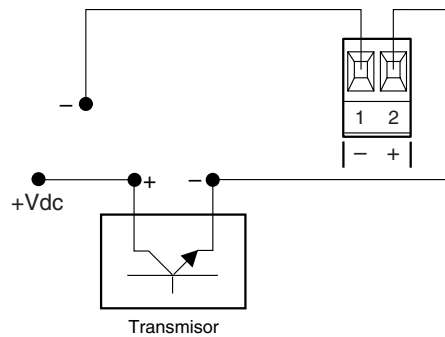

Detail - External Power Supply

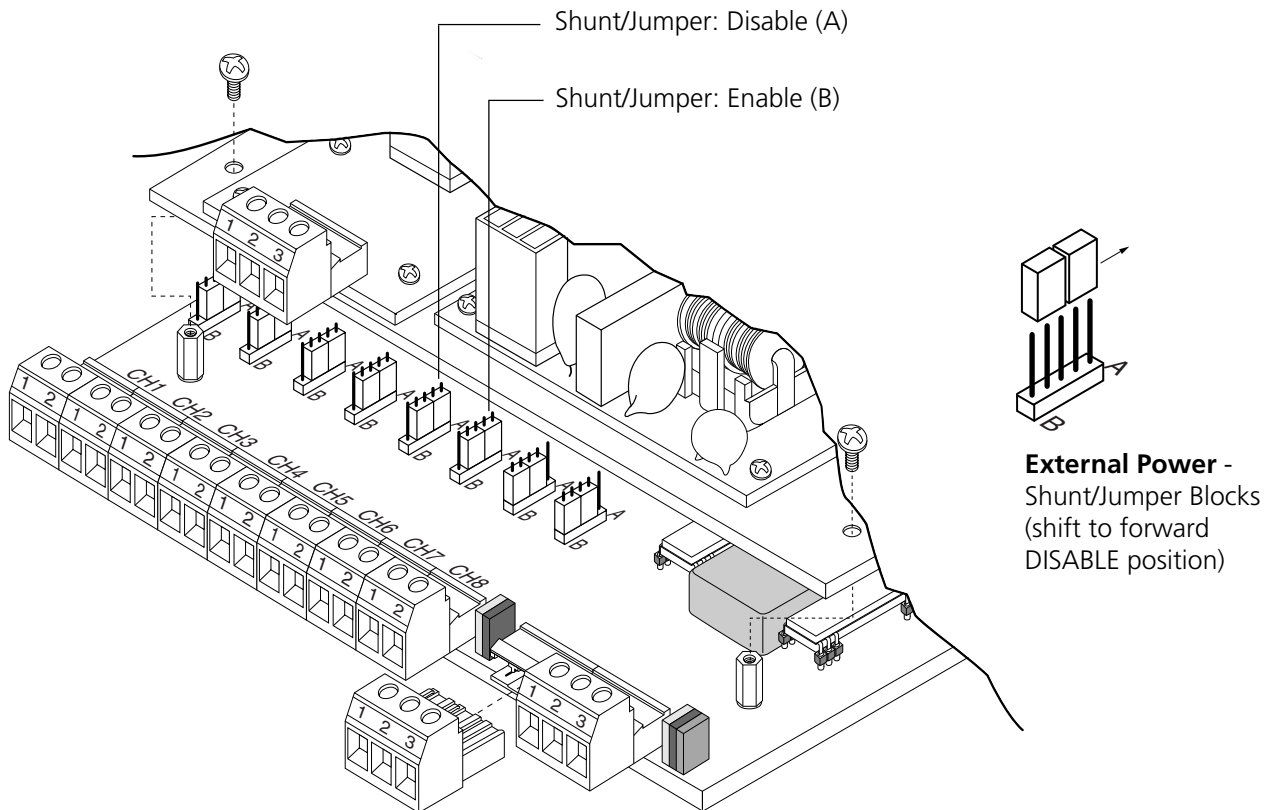

Application Programming (Datapack)

The LevelPRO Tank Processor expresses output directly in engineering units. The processor references a capacity profile to correlate transmitter output to actual tank geometry. The processor then displays the resulting value directly as the total weight or volume of liquid in the tank. All application details are factory programmed into nonvolatile memory.

Referred to as the Application Datapack, this iButton memory module contains a default liquid density value, readout units factor and tank name. In addition to battery backup, critical data such as the capacity profile are not user-addressable to prevent any possible corruption of the original factory programming.

Editing Specific Gravity Value: This avoids the need to re-range the level transmitter when the tank is used for more than one liquid product density. The external communications link is used to change specific gravity value from a remote terminal or PLC. (See Addendum)

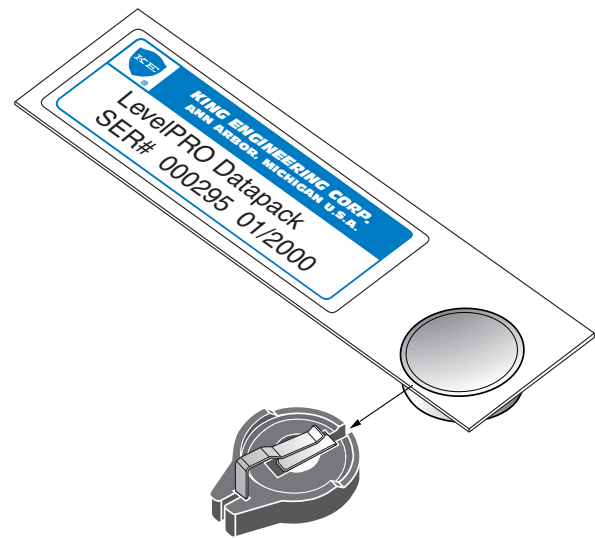

Detail - Datapack iButton and Socket

Installing Updated Datapack iButton

Non-addressable application parameters (i.e., tank name, network polling address, tank capacity profile) require updated datapack programmed at the factory. Use caution when accessing the datapack — internal circuitry and electrical connections should not be exposed to moisture. Turn off power to unit prior to handling internal components.

Turn off power or open the enclosure and disconnect the plug-in terminal connector. Datapack (iButton) is readily accessible at the upper portion of the circuit card.

- A. To remove datapack, lift up and slide datapack outward (see illustration) to remove datapack.
- B. To install datapack, slide datapack under clip. Make certain Datapack iButton is fully seated in socket.

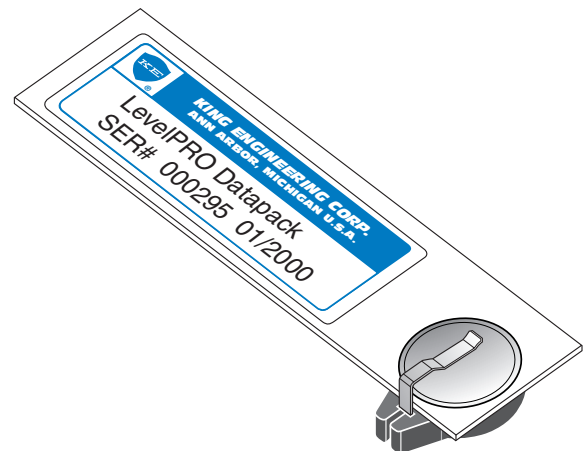

Detail - Datapack iButton installed

Troubleshooting Checklist

Certain problems experienced during initial system installation and start-up may result from incomplete connections. Optimum performance will occur when power and cabling recommendations are followed.

No Communication Output

Unit does not appear to be functioning

- Make certain that Tank Processor is connected to 115 Vac power source.
- Check internal fuse(s) on internal board set of Tank Processor and replace if necessary.

Low Reading

Level value being transmitted is inaccurately low, or does not rise when level increases.

- Check sensor/transmitter output (if necessary, check zero and span settings).
- Signal connections are reversed at the tank processor input terminals or were reversed at the transmitter terminals.
- Resistive load on signal loop exceeds capacity of transmitter at the supplied 24 Vdc excitation from the Tank Processor.

High Reading

Level value being transmitted is inaccurately high.

- Check sensor/transmitter output (if necessary, check zero and span settings).
- Check that tank vent is open. (Rapid fill rate may sometimes exceed venting capacity creating internal pressure in the tank.)
- Specific gravity of liquid in tank may be greater than that programmed into tank processor Datapack iButton.

Communications Troubleshooting Using LED Status Indicators

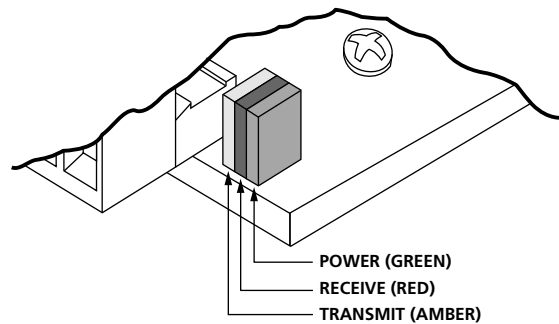

GREEN On = Power is On

GREEN Off = Power is Off

The green LED is illuminated when power is supplied to the unit. If the green LED is not lit, check that the external power supply is connected to unit. (Internal fuse may also be blown.)

AMBER On (Blinking) = Data Transmit

AMBER Off = Not Transmitting

The amber LED is illuminated during each data pulse transmission. During normal operation, the LED will be blinking on/off in combination with the red (receive) LED. If the receive (red) LED is functioning but there is no indication from the amber LED, unit may have an internal component failure.

RED On (Blinking) = Data Received

RED Off = No Data Received

RED Always On = RS-485 A + B Line Reversed

The red LED is illuminated in response to each data pulse received. During normal operation, the LED will be blinking on/off in combination with the amber (transmit) LED. If there is no indication from the red LED, there may be a problem with the data format from the host. If the red LED is continuously illuminated, this indicates a crossed connection between the A + B sides of the RS-485 two wire interface (try reversing the A + B connections at the LevelPRO).

Communications Interface - Network Systems

Network Communications (RS-485)

LevelPRO tank processors can provide direct ASCII communications via a two wire multi-drop network interface. Recommended communications cable is Belden 9501 (24 AWG twisted pair stranded conductors, copper drain wire, overall shielding).

Connections are provided on the plug in terminal for A, B and SH (shield). Refer to the RS-485 diagram for proper cabling connections. Up to 32 individual LevelPRO devices can be installed on a multi-drop network.

Communications Port Protocols

| | |
|---------------|---------------|
| <u>Port A</u> | <u>Port B</u> |
| ASCII* | Modbus* |
| Satellite | ASCII |

LevelPRO tank level processors offer true digital communications to PLCs or computer based host devices. The communications interface may be implemented as a query/response format or continuous broadcast (Satellite mode). In the query/response format, Individual channels (corresponding to specific tanks or vessels) are addressable by the host or receiving device. This may be either a request to respond with level data or to change the specific gravity variable in use by the processor.

ASCII Protocol (Port A Default)

The standard communications mode for LevelPRO Tank Level Processors is based on a protocol using ASCII characters in a simple code structure. Any typical DOS or Windows based PC can communicate directly using this mode. With the presence of a BASIC module programmed with a simple communications routine, many PLCs can also interface directly with the LevelPRO processor.

ASCII mode supports a rich data message containing the channel address, 5-character specific gravity value, status indicator (full, empty), 8-character level value, 4-character units abbreviation and 2-byte number checksum. This data

output from the LevelPRO is generated whenever the processor receives an query or is downloaded with a specific gravity by the host.

EIA RS-485 Half Duplex
 19.2k bps Baud Rate
 0 start bit
 8 data bits
 1 stop bit

Satellite (Broadcast) Mode

When this mode is programmed into the iButton Datapack, the LevelPRO does not respond to queries from an external device, but instead delivers a continuously broadcast ASCII mode output. This is the standard format rich data message (see above). This mode is specifically intended for communicating with LevelPRO Satellite remote display receivers.

ModBus Protocol (Port B Default)

King has developed ModBus communication protocols in order to interface LevelPRO tank level processors directly with Modicon programmable controllers. Specifications for ModBus were obtained from: *The Modicon ModBus Protocol Reference Guide* (PI-MBUS-300 Rev. H, April 1996).

The ModBus communication mode for LevelPRO Tank Level Processors is based on a emulating the remote terminal unit (RTU) code structure. Modicon programmable controllers equipped with a ModBus port can communicate directly using this mode. Many other types of PLCs can be enabled for communications through the use of a data converter, including Modicon controllers that only have an active ModBus Plus port.

EIA RS-485 Half Duplex
 RTU Mode (with CRC error checking)
 19.2k bps Baud Rate
 1 start bit
 8 data bits
 2 stop bits
 No Parity

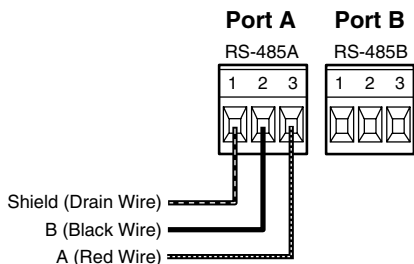

Cabling Connections
(LevelPRO)

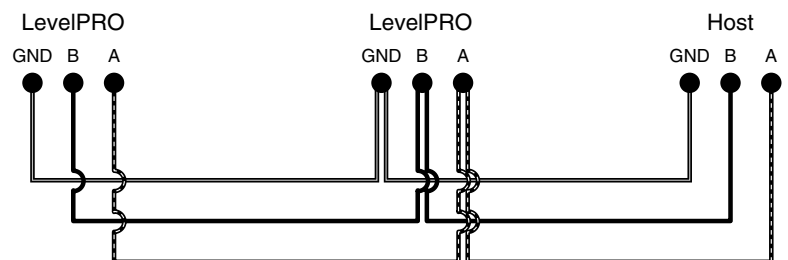

Detail - RS-485 diagram

King Bus ASCII Communications

Communications Technical Specifications:

- Two wire half-duplex with isolated ground
- Automatic signal level shifting for point-to-point (RS-422) and multi-drop (RS-485).
- ASCII character transmission formatted as (0) start bit, (8) data bits and (1) stop bit.
- Standard baud rate up to 19.2 kbps.

Host Polling Protocol

The host device must query LevelPRO processors to receive level data and/or to change specific gravity values. The query should be configured using the following ASCII code formats.

Request Level Data:

#NNN*

- # = Beginning character, first character sent (\$23 Hex)
- NNN** = 3 character ASCII polling address, 001-256
- * = Terminating character, last character sent (\$2A Hex)

Change Specific Gravity:

#NNN_S.SSS*

- # = Beginning character, first character sent (\$23 Hex)
- NNN** = 3 character ASCII polling address, 001-256
- _ = Space character (\$20 Hex)
- S.SSS** = 5 character specific gravity includes decimal (\$2E Hex) character
- * = Terminating character, last character sent (\$2A Hex)

LevelPRO Response Format

Communications output from individual processor in response to query by host.

31 Character Response:

NNN_S.SSS_XLLLLLLLL_UUUU_CCCC<CR><LF>

NNN = 3 character ASCII polling address, 001-256

_ = Space character (\$20 Hex)

S.SSS = 5 character specific gravity includes decimal (\$2E Hex) character

_ = Space character (\$20 Hex)

X = Status code; B (blank), F (full), R (reserve/empty), C (calibration mode)

LLLLLLLL = 8 character level value, leading zeros required if applicable

_ = Space character (\$20 Hex)

UUUU = 4 character units abbreviation/code in the form, GALS

_ = Space character (\$20 Hex)

CCCC = Check sum in ASCII representation of a 2-byte number in the form, OFE5

<CR> = Carriage return (\$0D Hex)

<LF> = Line feed (\$0A Hex)

Sample Response:

001_1.032_B00023900_GALS_04DC<CR><LF>

Checksum does not include the last space character (\$20), carriage return (\$0D), line feed (\$0A) or the checksum value itself.

The actual hex data transmission:

\$30 \$30 \$31 \$20 \$31 \$2E \$30 \$33 \$32 \$20 \$42 \$30 \$30
 \$30 \$32 \$33 \$39 \$30 \$30 \$20 \$47 \$41 \$4C \$53 \$20 \$30
\$35 \$34 \$33 \$0D \$0A

(Underlined values are not added to the preceding bytes to create the checksum.)

Introduction

King has developed MODBUS communication protocols in order to interface LevelPRO tank level processors directly with Modicon programmable controllers. Specifications for MODBUS were obtained from: *The Modicon Modbus Protocol Reference Guide* (PI-MBUS-300 Rev. H, April 1996). MODBUS Protocols and how they relate to obtaining level data from the LevelPRO are discussed.

Communications Hardware:

- KING-GAGE LevelPRO
- RS-485 (two wire multi-drop with an isolated ground) Half-Duplex
- Modicon, Square D, AEG, or any MODBUS compatible host device
- MODBUS Communications Port

Protocol Specification

The MODBUS controller programmer or user must configure the proper communication parameters. The required communication configurations for a MODBUS compatible LevelPRO system are listed below.

MODBUS-RTU Mode *(with CRC error checking)*

19.2k bps Baud Rate

1 Start Bit

8 Data Bits

2 Stop Bits

No Parity

The Cyclical Redundancy Check (CRC) field is two bytes, containing a 16-bit binary value calculated by the transmitting device which is added to the end of the message.

Master Query to Remote *(Slave)*

The controller acts as the host while the LevelPRO functions as the remote. The PLC will initiate all command functions. The PLC issues a Query while a LevelPRO sends a Response. A typical message frame is shown below.

| | | | | | |
|-------|---------|----------|------|-------------|-----|
| START | ADDRESS | FUNCTION | DATA | ERROR CHECK | END |
|-------|---------|----------|------|-------------|-----|

Address

Valid addresses range from 1-247 (01-F7 Hex) and are assigned by King unless otherwise noted by the customer or the systems integrator. Register numbers are assigned to each individual level data (READ) and specific gravity (WRITE) registers for each channel at a given LevelPRO address. Refer to Address/Register Map.

Functions

03 Read Holding Registers

This function reads a level data (READ) register. A register is capable of holding only 2-bytes worth of data (hi and low bytes). The largest value a register can hold is 7FFF in hex, or 32767 in decimal. LevelPRO processor calculates tank level and formats this value as a percent of 32767 placing it into the appropriate register.

The programmable controller will typically issue a starting address and specifies how many registers are requested.

06 Preset Single Register *(broadcast not used)*

This function allows the PLC to write a new specific gravity to the LevelPRO. The LevelPRO uses the specific gravity to account for a change of mass due to a new product in the vessel. The PLC will divide the specific gravity by the maximum allowed specific gravity, multiply by 32767, and place the value into the appropriate register (see example 2). With register 08 corresponding to a LevelPRO address of 01 and channel #1 specific gravity (see table on next page).

Example 1

PLC Initiates Read Function

The PLC issues a 03 Read Function to remote address 01, MODBUS register 00. This is a request for the data for only one (1) READ register at the LevelPRO. In response, the LevelPRO will format the level data according to the example below:

Register Data Calculation (LevelPRO)

LevelPRO Address = 01 (channel 1)
 MODBUS Register Number = 00 (see table)
 Number Of Registers = 1
 Tank Full Value = 10000 gals (constant variable)
 Level = 2000 gals

Register Value
 (Level / Full Value) x 32767
(2000/10000) x 32767 = 6553 = 1999 (in Hex)

A value of **1999** (Hex) will be placed in register 00. The PLC would issue a query to a LevelPRO at address 01 for value of MODBUS register 00. The PLC would receive a response from the LevelPRO and read the value of MODBUS register 00. The PLC program would "unformat" the data according to the example below.

Tank Level Calculation (PLC)

Tank Full Value = 10000 gals (constant variable)
 Level = (Full Value x Register Value) / 32767
Level = (10000 gals x 6553) / 32767 = 2000 gals

Example 2

PLC Initiates Write Function

The PLC issues a 06 Preset Single Register function to remote address 01, MODBUS register 40009.

This specifies a specific gravity value for only one (1) WRITE register at the LevelPRO. The PLC formats this specific gravity according to the following example:

Register Data Calculation (PLC)

LevelPRO Address = 01 (channel 1)
 MODBUS Register Number = 08 (see table)
 Max. Specific Gravity = 14 (constant variable)
 Specific Gravity = 1.032

Register Value
 (Specific Gravity / 14) x 65,534

55(1.032/14) x 65,534 = 2415 (rounded)=96F (in Hex)

A value of **09** (Hex) is then placed in the high byte and **6F** (Hex) is placed in the low byte of MODBUS register 08. The formatted data is then sent to the LevelPRO at address 01.

The following tables assign a register number for a given address and channel. Each LevelPRO is capable of having up to eight 4-20mA signals inputted via channels 1-8. Registers listed are either **READ** (Level Data) or **WRITE** (Specific Gravity). A READ type of operation is accomplished by issuing a **03** (Read Holding Register) function which requests level data. A WRITE type of operation is accomplished by issuing a **06** (Preset Single Register) function which sends a new specific gravity to be written to the LevelPRO memory.

Note: It is important when programming any address and channel that the WRITE register number must be 8 greater than the corresponding READ register number.

READ Register + 8 = WRITE Register

Addressing / Register Map

| TYPE | REMOTE ADDRESS | MODBUS REGISTER | TANK CHANNEL |
|-------|----------------|-----------------|--------------|
| READ | nn | 00 | 1 |
| READ | nn | 01 | 2 |
| READ | nn | 02 | 3 |
| READ | nn | 03 | 4 |
| READ | nn | 04 | 5 |
| READ | nn | 05 | 6 |
| READ | nn | 06 | 7 |
| READ | nn | 07 | 8 |
| WRITE | nn | 08 | 1 |
| WRITE | nn | 09 | 2 |
| WRITE | nn | 10 | 3 |
| WRITE | nn | 11 | 4 |
| WRITE | nn | 12 | 5 |
| WRITE | nn | 13 | 6 |
| WRITE | nn | 14 | 7 |
| WRITE | nn | 15 | 8 |

nn = two digit hex address designation of 1 (01) through 247 (F7).

Typical Message Structures

Query Sequence (PLC)

The PLC transmits a query to a specific LevelPRO processor (ADDRESS) to read (FUNCTION) the values from register (STARTING REGISTER HI/LO) through register (# OF REGISTERS HI/LO) with the check (CRC).

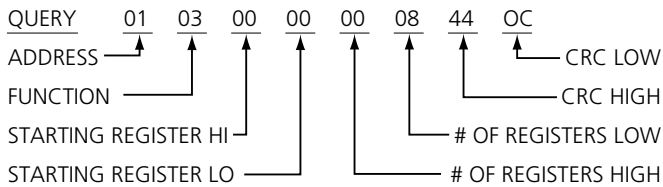

The LevelPRO (ADDRESS) acknowledges the write command (FUNCTION) and echos the gravity value (DATA) followed by the check (CRC).

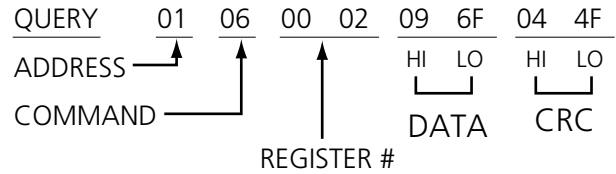

Data Packets

The data packets are transmitted sequentially beginning with the starting register (00). Since there are two bytes per register, the initial byte count in the message string confirms the number of register values that are transmitted.

Response Sequence (LevelPRO)

The specified LevelPRO (ADDRESS) responds to the query (FUNCTION) noting how many data packets (BYTE COUNT) being sent and the values (DATA) followed by the check (CRC).

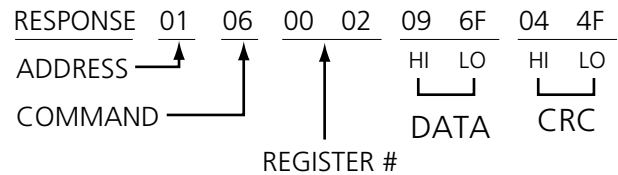

Specific Gravity Write (PLC)

The PLC transmits a command to a specific LevelPRO (ADDRESS) to write (FUNCTION) to a specific register (REGISTER#) a new gravity value (DATA) followed by the check (CRC).

Specific Gravity Write (LevelPRO)

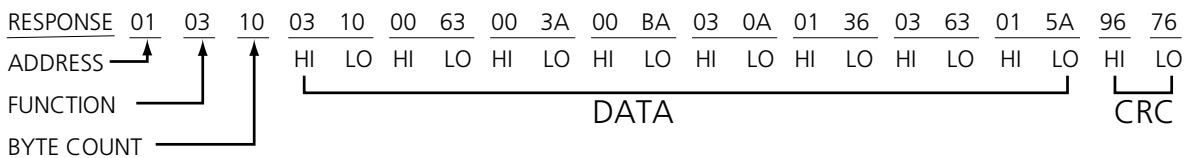



Box 1228, Ann Arbor, Michigan 48106-1228 U.S.A.
Phone: (734) 662-5691 ■ FAX: (734) 662-6652