

58 Series



WARNING

Read the recommendations and warnings in this manual before the instrument is installed. For personal safety, optimal use and maintenance of the KING-GAGE 5800 Series ES3 Transmitter, these instructions should be studied carefully.

KING-GAGE, A NOSHOK Company

The information contained in this manual was accurate at the time of release. Specifications are subject to change without notice.

Warranty - All King Engineering products are guaranteed to be free from defects in material and workmanship for one year from the date of purchase. Any product or part found to be defective under normal use within one year of purchase will be repaired or replaced at no charge if returned to the company at Berea, Ohio within ten days of discovery of the defect. No other warranties, whether expressed, implied, or statutory, including the warranties of fitness for a particular purpose or merchantability, are given by this agreement.

The exclusive remedy for nonconformity of these goods shall be repair and/or replacement of the nonconforming goods or parts.

Seller will not be liable for consequential damages resulting from breach of this agreement. The term "consequential damages" shall include but shall not be limited to damage to all machines, equipment and goods other than the goods sold hereby, interruption of production, loss of profits, delays of any kind, administrative expense and overhead.

Revisions:

- (A) March, 2008 – Original Release (applicable to ESR-serial no. versions)
- (B) August, 2008 – Illustrations based on encapsulated board (ESR-serial no. versions)
- (C) May, 2009 – molded cable w/ M12 plug connector
- (D) August, 2009 – revised span adjustment ranges
- (E) November, 2009 – ES2 Slimline version added
- (F) August, 2011 – revised remote junction notes
- (G) October, 2016 - model no.s (-3V) added for versions with FKM seal

TABLE OF CONTENTS

SECTION	PAGE
1 Introduction.....	3
2 Dimensional Drawings	3
3 Installing The Transmitter	4
3.1 Mounting position	4
3.2 Mounting position effect	4
3.3 Calibration.....	4
3.4 Connection Terminal.....	4
3.5 Wiring	4
4 Remaining	5
4.1 CE / EMC - Rules.....	5
4.2 Display and push buttons.....	5
4.3 Display read out	5
5 Summary Programming Points	6
5.1 Explanation Programming Points.....	6
P101 Zero Adjustment (Zero)	6
P102 Span Adjustment (Span).....	6
P103 Cancel Mounting Position Effect	7
P104 Display Setting Of Units	7
P105 Output Selection 4-20 Ma Or 20-4 Ma.....	8
P106 Damping Adjustment.....	8
P107 Temperature Units.....	8
P108 Device Setup.....	8
P109 Readout.....	9
P110 Burst Mode (Hart®)	9
P111 Information.....	10

1. INTRODUCTION

KING-GAGE 5800 Series ES3 Transmitters are solid-state pressure and level transmitters using a piezoresistive silicon sensor with a very high burst pressure. The sensor element is mounted in a Stainless Steel foot. Inside the foot a temperature sensor is also mounted to provide active temperature compensation at the point of measurement, to minimize temperature and position error. A compact, robust Stainless Steel flush diaphragm minimizes the amount of fill fluid and reduces the potential for damage. Diaphragms are laser welded and helium leak tested. A very small amount of oil fills the chamber surrounding the sensor and transfers pressure from the flush mounted diaphragm to the sensor.

Pressure on the sensor element creates a very small deflection of the silicon substrate and bridge network. The resulting strain in the silicon resistors causes a change in the bridge resistance that is proportional to the pressure applied. The transmitter electronics detects this change in bridge resistance and converts it into a measuring value. The amplifier system is based on a single Integrated Circuit, which ensures a perfect linearity in the output, all within an accuracy of 0.2 %. The flush diaphragm technology ensures reliable long-term stability.

2. DIMENSIONAL DRAWINGS

5800 Series ES3 Transmitters Transmitter

5800 Series ES3 Transmitters Transmitter

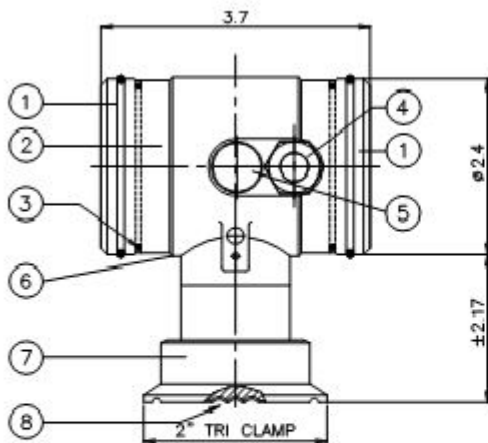

Front view: Transparent cover, option: I (extra price)

Description	Material	Description	Material
① Cover	AISI 304	⑤ Venting	PA
② Display with push buttons		⑥ Electronics housing	AISI 304
③ O-Ring	EPDM	⑦ Foot	AISI 316
④ M12		⑧ Flush Diaphragm	AISI 316L

3. INSTALLING THE TRANSMITTER

The transmitter's diaphragm is protected with a special protection cap. Protect the diaphragm until installation takes place. Do not damage the diaphragm.

3.1 MOUNTING POSITION

When the transmitter is mounted horizontally, the cable gland must be pointed downwards.

3.2 MOUNTING POSITION EFFECT

All transmitters are calibrated in vertical position (diaphragm points downwards). If the transmitter is mounted in another position, there can be a little zero shift. (example 4.02 mA instead of 4.00 mA). After installation of the transmitter the zero must be set to 4.00 mA with P103 (cancel mounting position effect). This will not affect the span.

3.3 CALIBRATION

All transmitters are fully calibrated at the factory, to customer specified range. If the calibration is not specified, the transmitter will be calibrated at the maximum span.

3.4 CONNECTION TERMINAL

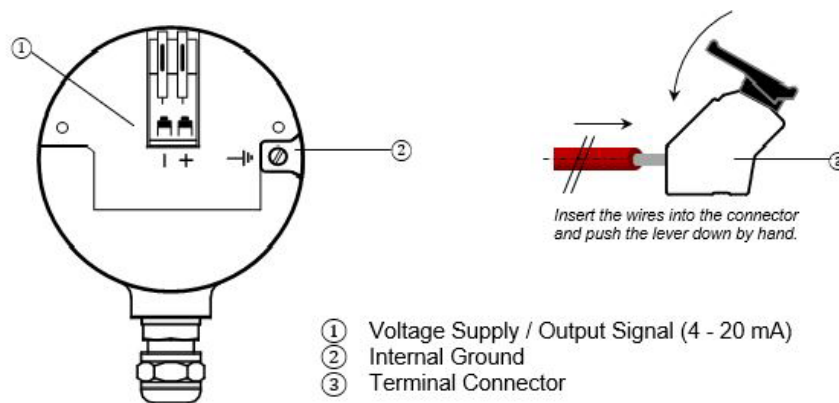

The figure above shows the wiring connection of the transmitter. The 2-wires must be connected to the terminal board. The wiring terminals can be operated without a screwdriver. The opening levers of the terminal can be lifted and pressed down by hand. Lift the opening levers of the terminals and insert the corresponding wires. Press down the levers by hand. The terminal spring will close and the wire is clamped.

3.5 WIRING

The transmitter must always be connected to ground. The transmitter must be connected with standard two-wire shielded cable. Do not run signal wiring in open trays with power wiring, or near heavy electrical equipment (Frequency controller or heavy pumps). Shielding must always be connected at the side of the power supply. In case the process connection is already connected to ground (by tank or pipe line) do not connect the instrument to ground. Please ensure that the instrument is not connected to ground twice to prevent an earth loop. In applications with synthetic process connections, the enclosure (internal or external) must be connected to ground.

Reversing the polarity will not damage the transmitter, but the transmitter will not function until the + and are properly connected.

⚠ Please ensure that the transmitter is not connected to ground twice to prevent an earth loop.



4 REMAINING

4.1 CE // EMC-RULES

These KING-GAGE transmitters are manufactured in accordance with the RFI/EMC directives and comply with the CE standard. All transmitters are fitted with RFI filters, which provide optimum, trouble-free operation. Our products are in conformity with EMC-Directive 2014/30/EU based on test results using harmonized standards.

4.2 DISPLAY AND PUSH BUTTONS

The KING-GAGE 5800 Series ES3 Transmitter has a high contrast display for optimal readout. The menu is controlled by 3 push buttons. Navigate with the up and down buttons through menus and measuring values.

-  Enter a menu and confirm selections with the menu button.
-  Push the up button to browse through various menus and adjusting values.
-  Push the down button to browse through various menus and adjusting values.

Push the menu button to enter menus or confirm a selection.

Display – 5800 Series



4.3 DISPLAY READOUT

When the transmitter is powered, a startup screen with the software version and the pressure range appears for a few seconds. After the startup screen the transmitter will automatically continue to the main screen with the actual measurement reading.

5 PUSH BUTTON FUNCTIONS

PROGRAM POINT	NAME	FUNCTION
P100	Menu-Exit menu	Start and exit
P101	ZERO value	Zero adjustment (ZERO 4 mA) with or without test pressure
P102	SPAN value	Span adjustment (SPAN 20 mA) with or without test pressure
P103	MOUNT correction	Cancel mounting position effect
P104	UNITS	Selection of engineering units
P105	REVERSE mA	Output selection: 4-20 mA or 20-4 mA
P106	DAMPING	Adjustable damping: 0.00 till 25.00 seconds
P107	TEMP UNITS	Temperature unit selection: Celsius or Fahrenheit
P108	DEVICE SETUP	Configuration: Protection, HART, Display mode, Display update
P109	READOUT	Readout options on display: Current, Unit, percentage and temperature
P110	BURST MODE	Continuously broadcast a standard HART reply message

5.1. EXPLANATION PROGRAMMING POINTS



ZERO ADJUSTMENT (ZERO)

P101

Zero value

The transmitter is set to 0 psi at atmospheric pressure. The ZERO can be adjusted at a lower or higher point. This will be explained step by step by an example.

Example: Increase ZERO till 1.45 psi.

1. The measuring unit of the transmitter is set to psi. If not, this can be selected by choosing the right measuring unit in program point **P104**.
2. Navigate to program point **P101**, and push the menu button to enter the menu.
3. The actual measured value appears on the display.
4. Increase this value with the arrow  button to 1.45 psi, push the  button till save appear on the display.
5. The transmitter will return to the home screen. The measurement value at atmospheric pressure is now 1.45 psi. With a applied pressure of 1.45 psi, the transmitter will display 4 mA.

The transmitter can be adjusted to zero in a real process situation. The transmitter will measure the pressure in an actual process. This measurement will be used as the zero value (4 mA).

1. Go to the home screen, the transmitter will display the actual measured value.
2. Push the  button until the actual measured zero and the message **ZERO PUSHED** appear on the display.
3. The transmitter will return to home screen.

P102

Span value

SPAN ADJUSTMENT (SPAN)

This setting can be used to adjust the range (SPAN) according to an entered value or adjusted with or without an applied pressure. The maximum pressure which can be measured: The measurement at **ZERO (P101)** + the entered value **SPAN (P102)**. If the **ZERO (P101)** is increased, the maximum measured value will automatically set higher at the same rate as the zero. This will be explained by an example.

Example: Measurement range 0 – 29 psi.

1. The **span** must be set at 29 psi
2. Navigate to program point **P102**, and push the menu button to enter the menu.

3. Adjust the **SPAN** with the push buttons to 29 psi and push the **(M)** button until save appears on the display.
4. The transmitter will return to the home screen.

The span can also be adjusted to a real process situation. The transmitter will measure the pressure in an actual process. This measurement will be used as the span value (20 mA).

1. Go to the home screen, the transmitter will display the actual measured value.
2. Push the **(↑)** button until the actual measured span and the message **SPAN PUSHED** appear on the display.
3. The transmitter will return to home screen.

- i** P102 is the adjustment of the total span.
 When a compound range must be adjusted (for example -14.5 till +43.5 psi), a span of 29 psi must be programmed.
 The Zero (P101) must be set at -14.5 psi. The transmitter is adjusted at - 14.5 psi = Zero and +43.5 psi = Span.

P103

Mount corr.

CANCEL MOUNTING POSITION EFFECT

All transmitters are calibrated vertically. If the transmitter is installed horizontally, the transmitter has a small "mounting position" effect on the zero. The pressure value displayed, will be for example 0.003 psi instead of 0.000 psi.

1. Navigate to program point **P103**, and push the menu button to enter the menu.
2. Two choices appear on the screen: **Set** and **Reset**.
 Choosing **Set** will adjust the zero to 0.000 psi in the mounting position when applicable.
 - Select **Set**, and push the menu button to confirm.
 - The corrected is value is shown on the display.
 - Push the menu button to save.
 Choosing **Reset** will put the transmitter back to factory setting. (vertical adjustment)
 - Select **Reset**, and push the menu button to confirm to reset back to factory setting.
 - The transmitter will return to the home screen.

⚠ Do not apply pressure when executing "Cancel mounting position effect"

P104

Units

DISPLAY SETTING OF UNITS

Various engineering units can be displayed on the display.
 Factory setting = psi

1. Navigate to program point P104, and push the menu button to enter the menu.
2. Several engineering units can be selected. Each selected engineering unit is automatically converted to the correct value of the corresponding unit.
3. Navigate through this menu and choose the required unit, push the menu button confirm.
4. The transmitter will return to the home screen. The measured reading will be displayed in the selected unit in the home screen.

⚠ The selected pressure unit is only visible on the display when UNITS is chosen in program point P109.

P105

Reverse mA

OUTPUT SELECTION 4-20 mA or 20-4 mAFactory setting = 4 - 20 mA

1. Navigate to program point **P105**, and push the menu button to enter the menu.
2. Two choices appear on the screen: **4-20** and **20-4**
3. Make an output choice and push the menu button to confirm.
4. The transmitter will return to the home screen.

P106

Damping

DAMPING ADJUSTMENT

The transmitter has an adjustable damping between 0.00 to 25.00 seconds.

Factory setting = 0.00 seconds

1. Navigate to program point **P106**, and push the menu button to enter the menu.
2. Two choices appear on the screen: **Set** and **Reset**
 - Choosing **Set** allows a value to be set between 0.00 and 25.00 seconds.
 - Select **Set**, and push the menu button to confirm.
 - Adjust the damping with the push buttons and push the menu button to confirm.
 - The transmitter will return to the home screen.
 - Choosing **Reset** will put the transmitter back to factory setting (0.00 seconds)
 - Select **Reset**, and push the menu button to confirm to reset back to factory setting.
 - The transmitter will return to the home screen.

P107

Temp Units

TEMPERATURE UNITS

In this menu the preferred temperature unit can be selected.

Factory setting = Fahrenheit

1. Navigate to program point **P107**, and push the menu button to enter the menu.
2. Two choices appear on the screen: **Fahrenheit** and **Celsius**.
3. Make a choice and push the menu button to confirm.
4. The transmitter will return to the home screen.

P108

Device Setup

DEVICE SETUP

In this menu, several operational settings can be made for the transmitter and the display.

1. Navigate to program point **P108**, and push the menu button to enter the menu.
2. Five choices appear on the screen:
 - LocProtect** : The transmitter can be protected against local adjustments
 - ComProtect** : The transmitter can be protected against adjustments with HART.
 - HART**[®] : Option for HART[®] 5 and HART[®] 7 communication.
 - DispMode** : Option for turning the display **on** or **off**.
 - Disp.Upd.**: Adjust the refresh rate of the measuring value on the display between 0.0 to 5.0 seconds. For example when this value is set to 2.0 seconds, the measuring value on the display will be refreshed every 2 seconds.
 - Select Set, and push the menu button to confirm.
 - Adjust the setting with the push buttons and confirm with the menu button.



- The transmitter will return to the home screen.
- Choosing Reset will put the transmitter back to factory setting (0.0 seconds).



READOUT

In this menu, the type of readout on the display can be adjusted.
Factory Setting = Unit

1. Navigate to program point **P109**, and push the menu button to enter the menu.
2. Four choices appear on the screen:
 - Current** : Current value (4 - 20 mA)
 - Unit** : Pressure unit (Selected in **P104**)
 - Percentage** : 0 - 100%
 - Temperature** : Actual process temperature (°F or °C) Indication , accuracy depending on sensor position.
3. Navigate to the desired choice, confirm by pushing the menu button.
4. The transmitter will return to the home screen.

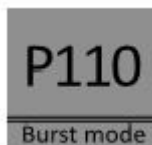

BURST MODE (HART®)

The transmitter (Only when HART® is present) can be configured for Burst mode.
This will enable continuously broadcasting standard HART® reply messages.

1. Navigate to program point **P110**, and push the menu button to enter the menu.
2. Five choices appear on the screen: **Mode Cntrl**, **Cmd number**, **Message**, **Period** and **Trigger**
3. Select **Mode Cntrl**, and push to confirm.
4. Two choices appear on the screen: **On** and **Off**
 - Choose **On** to turn on burst mode.
 - Choose **Off** to turn off burst mode.
5. Select **Message** to select the burst message 0,1,2 or 3 and push the menu button to confirm.
6. Select **Cmd number**, and push the menu button to confirm.

Five choices appear on the screen:

- **Cmd 01** = PRIMARY VARIABLE
- **Cmd 02** = CURRENT AND PERCENT OF RANGE
- **Cmd 03** = DYNAMIC VARIABLES AND CURRENT
- **Cmd 09** = DEVICE VARIABLES WITH STATUS
- **Cmd 48** = ADDITIONAL TRANSMITTER STATUS

Choose the preferable burst mode, and push menu button to confirm.

7. Select **Period**, and push the menu button to confirm.

Two choices appear on the screen: **Max Time** and **Min Time**

- Select **Max Time** to set the maximum amount of time when the message will be send. This value can be set from 0.5 to 3600 seconds.
- Select **Min Time** to set the minimum amount of time when the message will be send. This value can be set from 0.5 to 3600 seconds.

Enter the preferred value, and push the menu button to confirm.

8. Select **Trigger**, and push the menu button to confirm.

9. Five choices appear on the screen:

- Continuous** = The Burst message is send continuously.
- Windowed** = The Burst message is triggered when the measured value deviates more than the specified trigger value.
- Rising** = The Burst message is triggered when the measured value rises above the triggered value.
- Falling** = The Burst message is triggered when the measured value falls below the triggered value.
- On-Change** = The Burst message is triggered when any value in the measuring changing.

Choose the desired burst mode, and set the preferred parameters.



INFORMATION

This menu summarizes information about the configuration of the transmitter. Below the contents of the information screen.

