

Gaugeable Alloy 2507 Super Duplex Tube Fittings



- Available in sizes from 1/4 to 3/4 in.
- Excellent corrosion resistance in chloride-containing environments
- Advanced-geometry back ferrule design enhances sealing action
- NACE MR0175/ISO 15156 fittings available.
- Norsok M-630 and M-650 compliant.

Features

Swagelok alloy 2507 tube fittings utilize the same advanced geometry back ferrule design and patented ferrule hardening process as other Swagelok tube fittings, providing excellent vibration resistance and leak-tight gas seal. Alloy 2507 fittings are NORSOK M-630 and M-650 compliant as standard and are available in sizes from 1/4 to 3/4 in. Optional compliance to NACE MR0175/ISO 15156 is available for sour gas applications. All 2507 tube fitting components are manufactured from controlled chemistry material with a minimum pitting resistance equivalent (PRE) value of 42.5. Alloy 2507 fitting components are Positive Material Identification (PMI) tested with test reports available. Each Swagelok Alloy 2507 tube fitting component is stamped with its material type.

Materials of Construction



Component	Material	Marking
1 Nut	2507 super duplex SS	Notched hex, "2507" on face
2 Back ferrule	6-moly ^①	"254" or "6HN" on outer rim
3 Front ferrule	<i>2507 super duplex SS</i>	<i>"2507" on outer rim</i>
4 Body	<i>2507 super duplex SS</i>	<i>"2507" on neck</i>

Wetted components listed in *italics*.

① Alloy 254—UNS S31254; Alloy 6HN—UNS N08367.

⚠ Do not mix components of other materials with Alloy 2507 tube fittings.

Pressure Ratings

Pressure ratings for a fluid system are determined by the end connection or system component with the lowest pressure rating. Ratings for the end connections listed in this catalog are discussed below.

Swagelok Tube Fittings

Swagelok tube fittings listed in this catalog are rated to the pressure rating of the tubing (see table below).

Pressure Ratings for Swagelok Alloy 2507 Tube Fittings Used with Alloy 2507 Tubing

Pressure ratings are calculated from S values (38 700 psi [266 MPa]), in accordance with ASME B31.3, Process Piping. Tubing pressure ratings are for metal temperatures from –20 to 100°F (–28 to 37°C). Alloy 2507 tubing, fully annealed, meets ASTM A789 or equivalent. Hardness value is HRC 32 or less.

For lower temperature use, see **Low-Temperature Ratings**, page 3. For gas service, use tube wall thicknesses **outside** the shaded area.

Tube OD in.	Tube Wall Thickness, in.				
	0.035	0.049	0.065	0.083	0.095
	Working Pressure, psig (bar)				
1/4	10 000 (690)	15 000 (1040) ^①	—	—	—
3/8	6 500 (450)	10 100 (700) ^①	12 700 (880)	—	—
1/2	5 000 (350)	7 200 (500)	10 100 (700) ^①	12 900 (890)	—
5/8	—	5 800 (400)	7 600 (530)	10 100 (700)	—
3/4	—	4 700 (330)	6 300 (440)	8 500 (590)	10 000 (690)

① Pressure ratings based on special wall thickness tolerance for Swagelok Alloy 2507 tubing.

Metric 2507 Super Duplex Tubing

Tube OD mm	Tube Wall Thickness, mm				
	1.0	1.2	1.5	1.8	2.0
	Working Pressure, bar (psig)				
6	820 (11 900)	1034 (15 000)	—	—	—
10	470 (6 820)	580 (8 415)	740 (10 740)	—	—
12	390 (5 660)	490 (7 111)	650 (9 433)	689 (10 000)	689 (10 000)

Male NPT End Connections

Male NPT pipe end connections up to 1/2 in. are rated to 15 000 psig (1040 bar); sizes over 1/2 in. are rated to 10 000 psig (690 bar).

SAE/MS End Connections

SAE/MS end connections up to 1/2 in. are rated to 4500 psig (310 bar); sizes over 1/2 in. are rated to 3600 psig (250 bar), in accordance with SAE J1926.

Cone-and-Thread End Connections

Cone-and-thread end connections listed in this catalog are manufactured to API-6A "Specification for Wellhead and Christmas Tree Equipment". Sizes up to 9/16 in. are rated to 20 000 psig (1380 bar); sizes over 9/16 in. are rated to 10 000 psig (690 bar).

Refer to *Medium- and High-Pressure Fittings, Tubing, Valves, and Accessories* catalog, MS-02-472 and *Medium- and High-Pressure Fittings and Adapters* catalog, MS-02-474 for additional Cone-and-Thread fitting information.

Pressure Ratings

Elevated Temperature Ratings

Multiply working pressure from the table above by the appropriate factor to obtain working pressure at elevated temperatures.

Temperature °F (°C)	Elevated Temperature Factor ^①
200 (93)	0.99
400 (204)	0.91
600 (316)	0.89 ^②

① Elevated temperature factor = suggested allowable working pressure at elevated temperature / suggested allowable working pressure at room temperature.

② Use of 2507 super duplex stainless steel at temperatures above 482°F (250°C) causes microstructural changes that lead to embrittlement and loss of corrosion resistance. Derating factor at 482°F (250°C) is 0.90.

Example: 1/4 in. tubing with 0.035 in. wall at 400°F (204°C):
The working pressure at 100°F (37°C) is 10 000 psig (690 bar).
The temperature factor for 400°F (204°C) is 0.91.
10 000 psig (690 bar) × 0.91 is 9100 psig (628 bar).
The working pressure for 1/4 in. tubing with 0.035 in. wall at 400°F (204°C) is 9100 psig (628 bar).

NPT/ISO Pipe Pressure Ratings

Ratings are based on ASME Code for Pressure Piping B31.3, Process Piping, at ambient temperature.

NPT/ISO Pipe Size in.	Alloy 2507 and Alloy 625	
	Male	Female
	psig (bar)	psig (bar)
1/16	15 000 (1 033)	12 900 (888)
1/8	15 000 (1 033)	12 500 (861)
1/4	15 000 (1 033)	12 700 (875)
3/8	15 000 (1 033)	10 200 (702)
1/2	14 800 (1 019)	9 400 (647)
3/4	10 000 (689)	8 900 (613)
1	10 000 (689)	8 500 (585)

- To determine pressure ratings in accordance with ASME B31.1, Power Piping:
 - carbon steel material—multiply by 0.85.
- To determine MPa, multiply bar by 0.10.

Low-Temperature Ratings

Fitting pressure ratings are for metal temperatures from –50 to 100°F (–46 to 37°C), based on –50°F (–46°C) impact tests performed on Alloy 2507 bar and forgings. The tubing listed in the table on page 2 has a minimum use temperature of –20°F (–28°C) in accordance with ASME B31.3.

However, the Norsok M-001 Materials Selection standard allows this tubing to be used at a minimum temperature of –50°F (–46°C). According to the Norsok M-630 Material Data Sheets for Piping, Alloy 2507 tubing does not have to undergo low-temperature impact testing so long as wall thicknesses are below 0.236 in. (6 mm).

STH SAE/MS Heavy Duty Pressure Ratings

Pressure ratings are based on SAE J1926/2 at ambient temperature.

STH SAE/MS Thread Size	Designator	Alloy 2507	
		Non- positionable	Positionable
		psig (bar)	psig (bar)
3/8-24	3STH	9137 (630)	6091 (420)
7/16-20	4STH		
1/2-20	5STH		
9/16-18	6STH		
3/4-16	8STH		
7/8-14	10STH		
1 1/16-12	12STH	6091 (420)	

SAE/MS Fittings Pressure Ratings

Pressure ratings are based on SAE J1926/3 at ambient temperature.

SAE/MS Thread Size	Designator	Alloy 2507	
		Non- positionable	Positionable
		psig (bar)	psig (bar)
5/16-24	2ST	5076 (350)	5076 (350)
3/8-24	3ST		4568 (315)
7/16-20	4ST		
1/2-20	5ST		4061 (280)
9/16-18	6ST		
3/4-16	8ST	4568 (315)	3045 (210)
7/8-14	10ST	3625 (250)	
1 1/16-12	12ST		

NACE Certification

To purchase NACE compliant Alloy 2507 fittings for use in sour gas, add **-SG2** to the ordering number. Fittings with -SG2 designator are compliant to NACE MR0175/ISO 15156 (Table A.24):

Upon request, Swagelok can provide certification that includes the NACE statement:

The above fitting(s) meet(s) NACE MR0175/ISO 15156 (NACE) requirements, according to the following parameters:

1. Fitting bodies marked **SG** are produced from type Alloy 2507 super duplex solution-annealed material, UNS S32750, and meet the requirements for “any equipment” (Table A.24).
2. Some tube fitting components are produced from cold-drawn bar stock and, if wetted externally by sour gas, may not meet the requirements of NACE.

Ordering Information and Dimensions

- Dimensions are for reference only and are subject to change.
- Dimensions are shown with Swagelok tube fitting nuts finger-tight. For Swagelok nut dimensions, see page 8.
- The *E* dimension is the minimum nominal opening.
- CAD templates are available on www.swagelok.com.

Straight Fittings

Unions

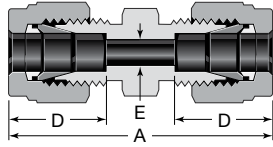

Tube OD in.	Ordering Number	Dimensions, in. (mm)		
		A	D	E
1/4	2507-400-6	1.61 (40.9)	0.60 (15.2)	0.19 (4.8)
3/8	2507-600-6	1.77 (45.0)	0.66 (16.8)	0.28 (7.1)
1/2	2507-810-6	2.02 (51.3)	0.90 (22.9)	0.41 (10.4)
5/8	2507-1010-6	2.11 (53.5)	0.96 (24.4)	0.50 (12.7)
3/4	2507-1210-6	2.11 (53.5)	0.96 (24.4)	0.62 (15.9)

Bulkhead Unions

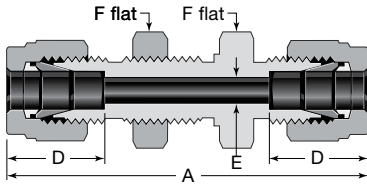

Tube OD in.	Ordering Number	Dimensions, in. (mm)					
		A	D	E	F	Panel Hole Size	Max Panel Thickness
1/4	2507-400-61	2.27 (57.7)	0.60 (15.2)	0.19 (4.8)	5/8	29/64	0.40 (10.2)
3/8	2507-600-61	2.45 (62.2)	0.66 (16.8)	0.28 (7.1)	13/16	37/64	0.44 (11.2)
1/2	2507-810-61	2.80 (71.1)	0.90 (22.9)	0.41 (10.4)	1 1/16	49/64	0.50 (12.7)
5/8	2507-1010-61	3.11 (78.9)	0.96 (24.4)	0.50 (12.7)	1 3/16	1 1/64	0.66 (16.8)
3/4	2507-1210-61	3.33 (84.5)	0.96 (24.4)	0.62 (15.9)	1 3/8	1 9/64	0.75 (19.0)

Male Connectors

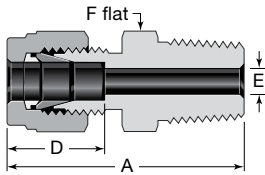

NPT

Tube OD in.	NPT Size	Ordering Number	Dimensions, in. (mm)			
			A	D	E	F
1/4	1/4	2507-400-1-4	1.49 (37.8)	0.60 (15.2)	0.19 (4.8)	9/16 7/8
	1/2	2507-400-1-8	1.76 (44.7)			
3/8	1/4	2507-600-1-4	1.57 (39.9)	0.66 (16.8)	0.28 (7.1)	5/8 11/16 7/8
	3/8	2507-600-1-6	1.57 (39.9)			
	1/2	2507-600-1-8	1.82 (46.2)			
1/2	1/4	2507-810-1-4	1.71 (43.4)	0.90 (22.9)	0.28 (7.1) 0.38 (9.7) 0.41 (10.4)	13/16 13/16 7/8
	3/8	2507-810-1-6	1.71 (43.4)			
	1/2	2507-810-1-8	1.93 (49.0)			
5/8	1/2	2507-1010-1-8	1.99 (50.5)	0.96 (24.4)	0.47 (11.9)	1 1/16
3/4	3/4	2507-1210-1-12	1.99 (50.5)	0.96 (24.4)	0.62 (15.9)	1 3/16 1 3/8
	1	2507-1210-1-16	2.25 (57.1)			

Straight Fittings

Male Connectors

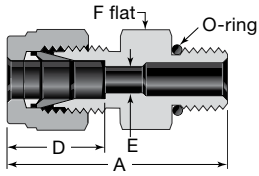

SAE/MS Straight Thread (ST)

Tube OD in.	SAE/MS Thread Size	Ordering Number	Dimensions, in. (mm)				Uniform O-ring Size ^②
			A	D	E ^①	F	
1/4	7/16-20	2507-400-1-4ST	1.34 (34.0)	0.60 (15.2)	0.19 (4.8)	9/16	904
	9/16-18	2507-400-1-6ST	1.40 (35.6)				
3/8	9/16-18	2507-600-1-6ST	1.46 (37.1)	0.66 (16.8)	0.28 (7.1)	11/16	906
1/2	9/16-18	2507-810-1-6ST	1.54 (39.1)	0.90 (22.9)	0.28 (7.1)	13/16	906
	3/4-16	2507-810-1-8ST	1.65 (41.9)				
5/8	7/8-14	2507-1010-1-10ST	1.77 (44.9)	0.96 (24.4)	0.50 (12.7)	1 1/16	910
3/4	1 1/16-12	2507-1210-1-12ST	1.93 (49.0)	0.96 (24.4)	0.62 (15.6)	1 3/8	912

① May be back drilled to larger ID at straight thread end.

② Standard O-ring material is 90 durometer fluorocarbon FKM.

Cone-and-Thread

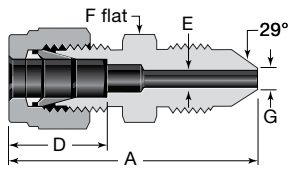

Tube OD in.	Medium-Pressure Tube Size in.	Ordering Number	Dimensions, in. (mm)					Thread Size
			A	D	E	F	G	
1/4	1/4	2507-400-1-4MP	1.62 (41.1)	0.60 (15.2)	0.11 (2.8)	1/2	0.14 (3.6)	7/16-20 UNF-2
3/8	3/8	2507-600-1-6MP	1.92 (48.8)	0.66 (16.8)	0.21 (5.3)	5/8	0.25 (6.4)	9/16-18 UNF-2
1/2	9/16	2507-810-1-9MP	2.15 (54.6)	0.90 (22.9)	0.31 (7.9)	7/8	0.41 (10.4)	13/16-16 UN-2
5/8	9/16	2507-1010-1-9MP	2.24 (56.8)	0.96 (24.4)	0.31 (7.9)	1 1/16	0.41 (10.4)	13/16-16 UN-2
3/4	3/4	2507-1210-1-12MP	2.53 (64.2)	0.96 (24.4)	0.45 (11.5)	1 3/16	0.56 (14.2)	3/4-14 NPSM-2

Cone-and-Thread Female Connectors

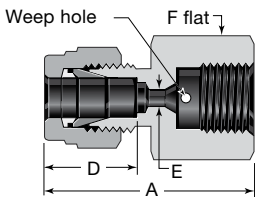

Tube OD in.	Medium-Pressure Tube Size in.	Ordering Number	Dimensions, in. (mm)				Thread Size
			A	D	E	F	
1/4	1/4	2507-400-7-4MP	1.37 (34.8)	0.60 (15.2)	0.11 (2.8)	11/16	7/16-20 UNF-2
3/8	3/8	2507-600-7-6MP	1.57 (39.9)	0.66 (16.8)	0.20 (5.1)	7/8	9/16-18 UNF-2
1/2	9/16	2507-810-7-9MP	1.96 (49.8)	0.90 (22.9)	0.36 (9.1)	1 1/16	13/16-16 UN-2

Reducers

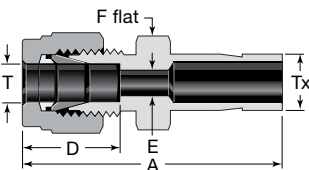

Tube OD, in.		Ordering Number	Dimensions, in. (mm)			
T	Tx		A	D	E	
1/4	3/8	2507-400-R-6	1.60 (40.6)	0.60 (15.2)	0.19 (4.8)	
	1/2	2507-400-R-8	1.82 (46.2)			
3/8	1/4	2507-600-R-4	1.63 (41.4)	0.66 (16.8)	0.17 (4.3)	
	1/2	2507-600-R-8	1.91 (48.5)			0.28 (7.1)
1/2	1/4	2507-810-R-4	1.77 (45.0)	0.90 (22.9)	0.17 (4.3)	
	3/8	2507-810-R-6	1.84 (46.7)			0.27 (6.9)
	3/4	2507-810-R-12	2.12 (53.8)			0.41 (10.3)
3/4	1/2	2507-1210-R-8	2.20 (55.8)	0.96 (24.4)	0.37 (9.3)	

Straight Fittings

Port Connectors

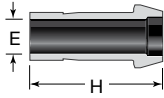

Tube OD in.	Ordering Number	Dimensions, in. (mm)	
		E	H
1/4	2507-401-PC	0.17 (4.3)	0.98 (24.9)
3/8	2507-601-PC	0.27 (6.9)	1.05 (26.7)
1/2	2507-811-PC	0.37 (9.3)	1.43 (36.3)
5/8	2507-1011-PC	0.47 (12.0)	1.49 (37.8)
3/4	2507-1211-PC	0.58 (14.7)	1.49 (37.8)

Caps

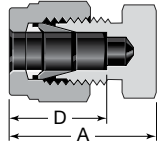

Tube OD in.	Ordering Number	Dimensions, in. (mm)	
		A	D
1/4	2507-400-C	0.92 (23.4)	0.60 (15.2)
3/8	2507-600-C	1.01 (25.7)	0.66 (16.8)
1/2	2507-810-C	1.15 (29.2)	0.90 (22.9)
5/8	2507-1010-C	1.24 (31.5)	0.96 (24.4)
3/4	2507-1210-C	1.34 (34.0)	0.96 (24.4)

Plugs

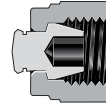

Tube OD in.	Ordering Number
1/4	2507-400-P
3/8	2507-600-P
1/2	2507-810-P
5/8	2507-1010-P
3/4	2507-1210-P

Union Elbows

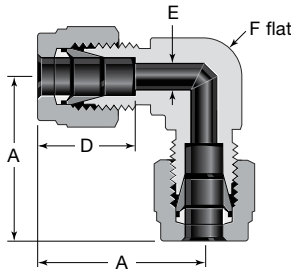

Tube OD in.	Ordering Number	Dimensions, in. (mm)			
		A	D	E	F
1/4	2507-400-9	1.06 (26.9)	0.60 (15.2)	0.19 (4.8)	1/2
3/8	2507-600-9	1.20 (30.5)	0.66 (16.8)	0.28 (7.1)	5/8
1/2	2507-810-9	1.42 (36.1)	0.90 (22.9)	0.41 (10.4)	13/16
5/8	2507-1010-9	1.57 (39.8)	0.96 (24.4)	0.50 (12.7)	1 1/16
3/4	2507-1210-9	1.70 (43.1)	0.96 (24.4)	0.62 (15.9)	1 3/16

Union Tees

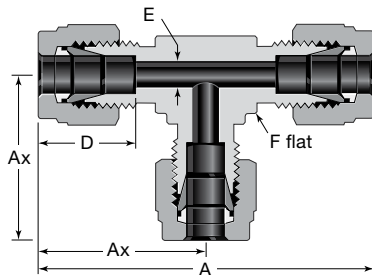

Tube OD in.	Ordering Number	Dimensions, in. (mm)				
		A	Ax	D	E	F
1/4	2507-400-3	2.12 (53.8)	1.06 (26.9)	0.60 (15.2)	0.19 (4.8)	1/2
3/8	2507-600-3	2.40 (61.0)	1.20 (30.5)	0.66 (16.8)	0.28 (7.1)	5/8
1/2	2507-810-3	2.84 (72.1)	1.42 (36.1)	0.90 (22.9)	0.41 (10.4)	13/16
5/8	2507-1010-3	3.14 (79.6)	1.57 (39.8)	0.96 (24.4)	0.50 (12.7)	1 1/16
3/4	2507-1210-3	3.40 (86.2)	1.70 (43.1)	0.96 (24.4)	0.62 (15.9)	1 3/16

Union Crosses

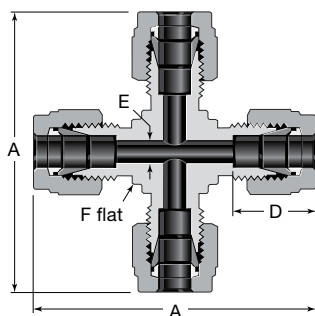

Tube OD in.	Ordering Number	Dimensions, in. (mm)			
		A	D	E	F
1/4	2507-400-4	2.12 (53.8)	0.60 (15.2)	0.19 (4.8)	1/2
3/8	2507-600-4	2.40 (61.0)	0.66 (16.8)	0.28 (7.1)	5/8
1/2	2507-810-4	2.84 (72.1)	0.90 (22.9)	0.41 (10.4)	13/16

Tube Adapters

Male Adapters

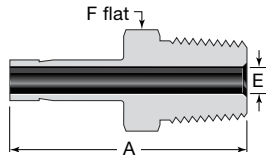

NPT

Tube OD in.	NPT Size in.	Ordering Number	Dimensions		
			A	E	F
1/4	1/4	2507-4-TA-1-4	1.46 (37.1)	0.17 (4.3)	9/16
3/8	1/4	2507-6-TA-1-4	1.53 (38.9)	0.27 (6.9)	9/16
	3/8	2507-6-TA-1-6	1.56 (39.6)		11/16
	1/2	2507-6-TA-1-8	1.78 (45.2)		7/8
1/2	1/4	2507-8-TA-1-4	1.75 (44.4)	0.28 (7.1)	9/16
	1/2	2507-8-TA-1-8	2.00 (50.8)	0.37 (9.4)	7/8
5/8	1/2	2507-10-TA-1-8	2.06 (52.3)	0.47 (11.9)	7/8
3/4	3/4	2507-12-TA-1-12	2.06 (52.3)	0.58 (14.7)	1 1/16

SAE/MS Straight Thread (ST)

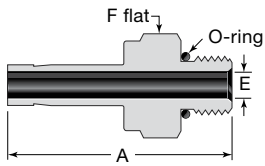

Tube OD in.	SAE/MS Thread Size	Basic Ordering Number	Dimensions			Uniform O-ring Size ^①
			A	E	F	
1/4	7/16-20	2507-4-TA-1-4ST	1.39 (35.3)	0.17 (4.3)	9/16	904
3/8	7/16-20 9/16-18	2507-6-TA-1-4ST	1.46 (37.1)	0.20 (5.1) 0.27 (6.9)	9/16	904 906
		2507-6-TA-1-6ST	1.52 (38.6)		11/16	
1/2	9/16-18 3/4-16	2507-8-TA-1-6ST	1.74 (44.2)	0.28 (7.1) 0.37 (9.4)	11/16	906 908
		2507-8-TA-1-8ST	1.82 (46.2)		7/8	
3/4	1 1/16-12	2507-12-TA-1-12ST	2.10 (53.3)	0.58 (14.7)	1 1/4	912

① Standard O-ring material is 90 durometer fluorocarbon FKM.

Cone-and-Thread Fitting

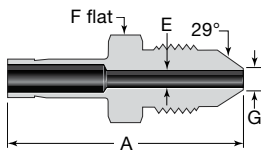

Tube OD in.	Medium-Pressure Tube Size in.	Ordering Number	Dimensions, in. (mm)				Thread Size
			A	E	F	G	
1/4	1/4	2507-4-TA-1-4MP	1.56 (39.6)	0.11 (2.8)	1/2	0.14 (3.6)	7/16-20 UNF-2
3/8	3/8	2507-6-TA-1-6MP	1.86 (47.2)	0.21 (5.3)	5/8	0.25 (6.4)	9/16-18 UNF-2
1/2	9/16	2507-8-TA-1-9MP	2.24 (56.9)	0.31 (7.9)	7/8	0.41 (10.4)	13/16-16 UN-2
5/8	9/16	2507-10-TA-1-9MP	2.40 (61.0)	0.31 (7.9)	7/8	0.41 (10.4)	13/16-16 UN-2
3/4	3/4	2507-12-TA-1-12MP	2.68 (68.1)	0.45 (11.5)	1 1/8	0.56 (14.2)	3/4-14 NPSM-2

Cone-and-Thread Female Adapters

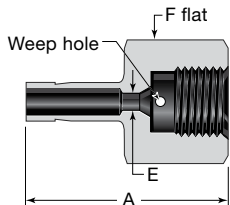

Tube OD in.	Medium-Pressure Tube Size in.	Ordering Number	Dimensions, in. (mm)			Thread Size
			A	E	F	
1/4	1/4	2507-4-TA-7-4MP	1.31 (33.3)	0.11 (2.8)	11/16	7/16-20 UNF-2
3/8	3/8	2507-6-TA-7-6MP	1.51 (38.4)	0.20 (5.1)	7/8	9/16-18 UNF-2
1/2	9/16	2507-8-TA-7-9MP	2.05 (52.1)	0.36 (9.1)	1 1/16	13/16-16 UN-2

Replacement Parts

Nuts

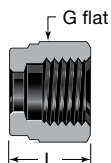

Tube OD in.	Ordering Number	Dimensions in. (mm)	
		G	L
1/4	2507-402-1	9/16	0.50 (12.7)
3/8	2507-602-1	11/16	0.56 (14.2)
1/2	2507-812-1	7/8	0.69 (17.4)
5/8	2507-1012-1	1 1/8	0.69 (17.4)
3/4	2507-1212-1	1 1/4	0.69 (17.4)

Ferrules

Front



Tube OD in.	Ordering Number
1/4	2507-403-1
3/8	2507-603-1
1/2	2507-813-1
5/8	2507-1013-1
3/4	2507-1213-1

Back



Tube OD in.	Ordering Number
1/4	6ML-404-1A
3/8	6ML-604-1A
1/2	6ML-814-1A
5/8	6ML-1014-1A
3/4	6ML-1214-1A

Cleaning and Packaging

Fitting components are cleaned to remove machine oil, grease, and loose particles. Refer to *Standard Cleaning and Packaging (SC-10)* catalog, MS-06-62, for additional information.

Tools for Use with Alloy 2507 Tube Fittings

Preswaging Tools



For Swagelok tube fitting installations in close quarters, the Swagelok preswaging tool is a convenient accessory.

Tube OD in.	Ordering Number
1/4 ^①	MS-ST-400GA
3/8 ^①	MS-ST-600GA
1/2 ^①	MS-ST-810GA
5/8	MS-ST-2507-1010
3/4	MS-ST-2507-1210

^① Ordering numbers containing **GA** at the end are gaugeable preswage tools, all others are non-gaugeable preswage tools.

Features

- Preswages ferrules onto the tube
- Enables the installer to work in a more open, safe area
- Makes it possible to complete the installation by following retightening instructions for Swagelok tube fittings

Multihead Hydraulic Swaging Unit (MHSU)



- Preswages Swagelok ferrules onto 5/8 and 3/4 in. Alloy 2507 tubing. For 5/8 and 3/4 in. Alloy 2507 tubing, order the 1 in./25 mm and over unit and Alloy 2507 tooling. The MHSU cannot be used for Alloy 2507 tubing 1/2 in. and under.
- Provides Swagelok tube fittings that are 100 % gaugeable when installed
- Places no initial strain on fitting body threads or on body seal surfaces
- Is standard with a tube marking feature to indicate when tube is properly bottomed

Description	Ordering Number
MHSU only (1 in. and over unit)	MS-MHSU-O-E
5/8 in. tooling	MS-MHSUT-O-2507-1010-M
3/4 in. tooling	MS-MHSUT-O-2507-1210-M

Refer to *Gaugeable Tube Fittings and Adapter Fittings* catalog, MS-01-140, for additional information. For instructions, refer to *Multihead Hydraulic Swaging Unit (MHSU) Setup and Operation Instructions*, MS-12-37.

Tools for Use with Alloy 2507 Tube Fittings

Gap Inspection Gauges

Swagelok gap inspection gauges assure the installer or inspector that the fitting has been sufficiently pulled up on initial installation, whether using a multihead hydraulic swaging unit (MHSU) or wrench tightening.

For Installation Using a Wrench



Tube OD in.	Ordering Number
1/4	MS-IG-400
3/8	MS-IG-600
1/2	MS-IG-810
5/8	MS-IG-2507-1010
3/4	MS-IG-2507-1210

For Installation Using the MHSU



Tube OD in.	Ordering Number
5/8	MS-MHSU-IG-2507-1010
3/4	MS-MHSU-IG-2507-1210

Depth Marking Tools



Swagelok depth marking tools help ensure that tubing is bottomed on the shoulder inside the Swagelok tube fitting body.

Tube OD in.	Ordering Number
1/4	MS-DMT-400
3/8	MS-DMT-600
1/2	MS-DMT-810
5/8	MS-DMT-1010
3/4	MS-DMT-1210

Gaugeability

On initial installation, the Swagelok gap inspection gauge assures the installer or inspector that a fitting has been sufficiently tightened.

Position the Swagelok gap inspection gauge next to the gap between the nut and body.

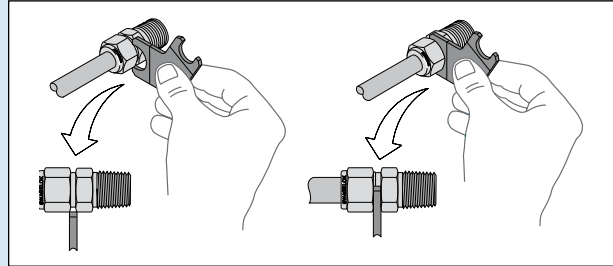

If the gauge **will not** enter the gap, **the fitting is sufficiently tightened.**

If the gauge **will** enter the gap, **additional tightening is required.**

⚠ Always depressurize the system before adjusting the tightness of a tube fitting connection.

Interchangeability

Swagelok recommends NO intermix/interchange of Swagelok tube fitting components with other manufacturers' components.

- No industrial design standard exists for two ferrule tube fittings. Each company makes components to its own design and not to any recognized standards.
- Interchanging and intermixing tube fitting components can result in unpredictable performance, environmental releases, increased costs, and can be dangerous in critical applications.

Installation Instructions

Swagelok Alloy 2507 super duplex tube fittings can be installed quickly, easily, and reliably.

Safety Precautions

- Do not bleed system by loosening fitting nut or fitting plug.
- Do not assemble or tighten fittings when system is pressurized.
- Make sure that the tube rests firmly on the shoulder of the tube fitting body before tightening the nut.
- Use the correct Swagelok gap inspection gauge to ensure sufficient pull-up upon initial installation.
- Always use proper thread sealants on tapered pipe threads.
- Do not mix materials or fitting components from various manufacturers—ferrules, nuts, and fitting bodies.
- Never turn fitting body. Instead, hold fitting body and turn nut.
- Avoid unnecessary disassembly of unused fittings.

Installation Instructions

Swagelok Tube Fittings

These instructions apply both to traditional fittings and to fittings with the advanced back-ferrule geometry.

Safe practices and proper installation are imperative to the performance of the Swagelok tube fitting, especially in critical applications.

For 5/8 and 3/4 tube fittings, in all materials except for aluminum and brass, it is a best practice to preswage the ferrules onto the tube using a Swagelok multihead hydraulic swaging unit (MHSU) to lower installation time and increase ease of installation (see Multihead Hydraulic Swaging Unit (MHSU), Setup and Operating Instructions, MS-12-37).

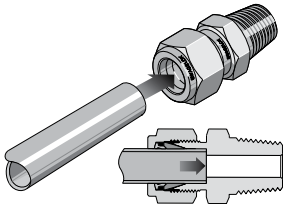

Fully insert the tube into the fitting and against the shoulder; rotate the nut finger-tight.

High-pressure applications and high safety-factor systems: Further tighten the nut until the tube will not turn by hand or move axially in the fitting.

Connections Preswaged with the MHSU

1. Preswage the ferrules onto the tube using a Swagelok multihead hydraulic swaging unit (MHSU).
2. Insert the tube with preswaged ferrules into the fitting until the front ferrule seats against the fitting body; rotate the nut finger-tight.

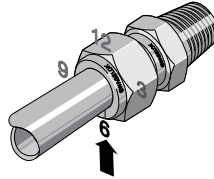

Mark the nut at the 6 o'clock position.

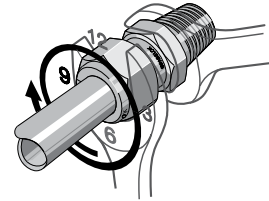

While holding the fitting body steady, tighten the nut one and one-quarter turns to the 9 o'clock position.

3. Mark the nut at the 6 o'clock position.
4. While holding the fitting body steady, tight the nut one-half turn to the 12 o'clock position.

Use the Swagelok MHSU gap inspection gauge to ensure that the fitting has been tightened sufficiently.

Reassembly

You may disassemble and reassemble Swagelok tube fittings many times.

⚠ Always depressurize the system before disassembling a Swagelok tube fitting.

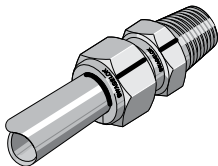

Prior to disassembly, mark the tube at the back of the nut; mark a line along the nut and fitting body flats.

Use these marks to ensure that you return the nut to the previously pulled-up position.

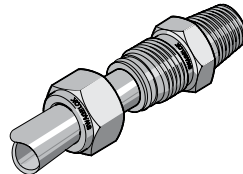

Insert the tube with preswaged ferrules into the fitting until the front ferrule seats against the fitting body.

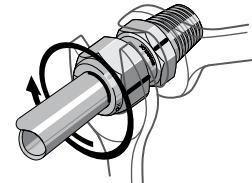

While holding the fitting body steady, rotate the nut with a wrench to the previously pulled-up position, as indicated by the marks on the tube and the flats. At this point, you will feel a significant increase in resistance. Tighten the nut slightly.

⚠ Do not use the Swagelok gap inspection gauge with reassembled fittings.

Caps and Plugs



Caps

See Swagelok tube fitting installation and reassembly, above.



Plugs

While holding fitting body steady, tighten the plug one-quarter turn from the finger-tight position.

⚠ Do not use the Swagelok gap inspection gauge with plug assemblies.

Reassembly

You may disassemble and reassemble Swagelok plugs many times. Make subsequent connections by slightly tightening with a wrench after snugging the nut by hand.

Installation Instructions

Port Connectors

Connect the machined ferrule end **before** connecting the tube adapter end.

Machined Ferrule End

1. Remove the nut and ferrules from the Swagelok end connection. Discard the ferrules.

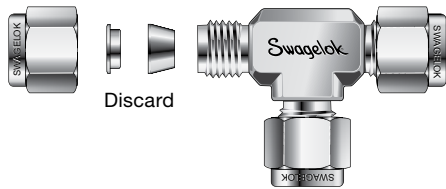

2. Slip the nut over the machined ferrule end of the port connector.
3. Insert the port connector into the end connection and finger-tighten the nut.

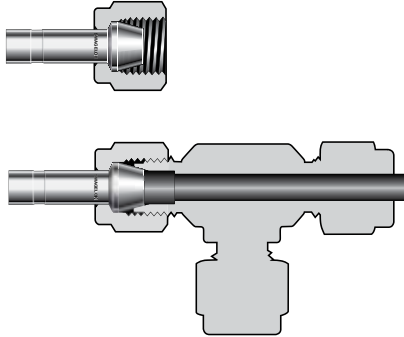

4. While holding fitting body steady, tighten the nut one-quarter turn.

⚠ Do not use the Swagelok gap inspection gauge with machined ferrule ends.

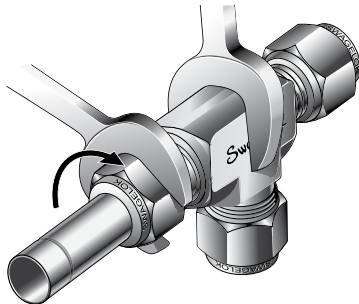

Reassembly

You may disassemble and reassemble Swagelok port connectors many times. Make subsequent connections by slightly tightening with a wrench after snugging the nut by hand.

Tube Adapter End

5. Insert the tube adapter until it rests firmly on the shoulder of the Swagelok tube fitting body. Finger-tighten the nut.

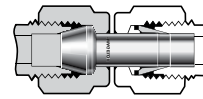

6. Mark the nut at the 6 o'clock position. While holding fitting body steady, tighten the nut one and one-quarter turns to the 9 o'clock position.

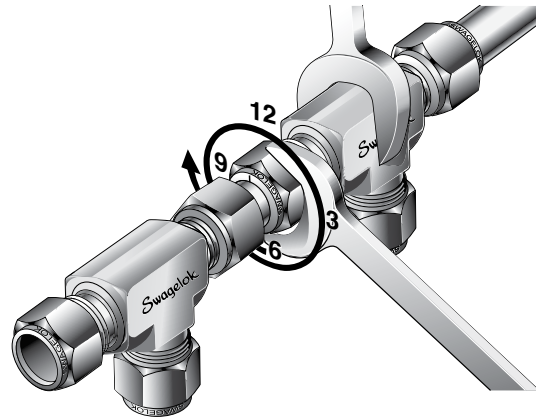

Reassembly

See Swagelok tube fitting reassembly, page 10.

Tube Adapters

Safe practices and proper installation are imperative to the performance of the Swagelok tube fitting, especially in critical applications.

For 5/8, 3/4, 7/8 and 1 in.; 16, 18, 20, 22 and 25 mm tube fittings, in all materials except for aluminum and brass, it is a best practice to preswage the ferrules onto the tube adapter using a Swagelok multihead hydraulic swaging unit (MHSU) to lower installation time and increase ease of installation (see Multihead Hydraulic Swaging Unit (MHSU), Setup and Operating Instructions, MS-12-37).

Fig. 1



Female pipe port on existing equipment

Fig. 2



1. Install the end opposite the tube adapter end (Fig. 1).
2. Insert the tube adapter into the Swagelok tube fitting. Make sure that the tube adapter rests firmly on the shoulder of the tube fitting body and that the nut is finger-tight (Fig. 2).
3. Mark the nut at the 6 o'clock position.

4. While holding fitting body steady, tighten the nut one and one-quarter turns to the 9 o'clock position.

Reassembly

See Swagelok tube fitting reassembly, page 10.

Installation Instructions

Depth Marking Tool

Fig. 1



Fig. 2



1. Insert cleanly cut, fully deburred tube into the depth marking tool (DMT) until the tube is against the shoulder of the tool. Using a pen or pencil, mark the tube at the top of the DMT (Fig. 1).
2. Remove the tube from the DMT and insert it into the Swagelok fitting until it is against the shoulder of the fitting body (Fig. 2). Rotate the nut finger-tight. If any portion of the mark on the tube can be seen above the fitting nut, the tube is not fully inserted into the fitting.

3. While holding the fitting body steady, follow Swagelok tube fitting installation instructions, page 10.

Non-Gaugeable Preswaging Tool

Fig. 1

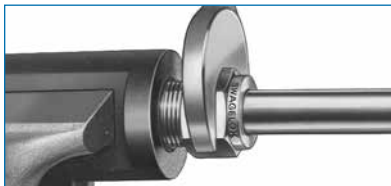

Fig. 2



Fig. 3



NOTE: These instructions apply only to the following non-gaugeable preswaging tools, MS-ST-2507-1010 (5/8 in. size) and MS-ST-2507-1210 (3/4 in. size). Tool will not have a colored band and the ordering number does not contain GA.

1. Install the Swagelok nut and ferrules onto the preswaging tool.
2. Insert the tube into the preswaging tool.
3. Make sure that the tube rests firmly on the shoulder of the preswaging tool body and that the nut is finger-tight.
4. Mark the nut at the 6 o'clock position.
5. While holding the preswaging tool steady, tighten the nut one and one-quarter turns to the 9 o'clock position (Fig. 1).
6. Loosen the nut.

7. Remove the tube with preswaged ferrules from the preswaging tool. If the tube sticks in the preswaging tool, remove the tube by gently rocking it back and forth. Do not turn the tube (Fig. 2).
8. Insert the tube with preswaged ferrules into the fitting until the front ferrule seats against the fitting body.
9. While holding the fitting body steady, rotate the nut with a wrench to the previously pulled-up position; at this point, you will feel a significant increase in resistance.
10. Tighten the nut slightly (Fig. 3).

⚠ Do not use the Swagelok gap inspection gauge with fittings that were assembled with MS-ST-2507-1010 and MS-ST-2507-1210.

Installation Instructions

Tools Required for Gaugeable Preswaging Tool Instructions

Fig. 1



Fig. 2



Fig. 3



Fig. 4



1. Gaugeable preswage tool will have a colored band (Fig. 1).

Gaugeable tools are available in sizes 1/4, 3/8, 1/2, and 5/8 in. (6, 8, 10, 12, and 16 mm)

Note: The 5/8 in. gaugeable tool cannot be used on alloy 2507 tubing.

2. Body wrench and nut wrench (Fig. 2).
3. Standard gap gauge for standard assembly (Fig. 3).
4. Severe-service gap gauge for severe service assembly (Fig. 4).

Gaugeable Preswaging Tool Instructions

Fig. 5



Fig. 6

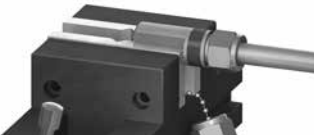
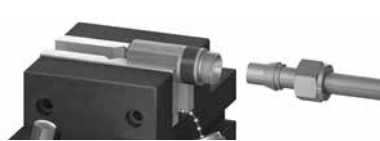

Fig. 7



Fig. 8



1. Install the Swagelok nut and ferrules onto the preswaging tool (Fig. 5).
2. Insert the tube into the preswaging tool until it rests firmly on the shoulder of the tool; rotate the nut finger-tight (Fig. 6).
3. While holding the preswaging tool steady, tighten the nut with a wrench until it stops against the collar (Fig. 7).
4. Loosen the nut and remove the tube with preswaged ferrules from the preswaging tool. If the tube sticks, gently rock it back and forth. Do not turn the tube (Fig. 8).

Installation Instructions

Gaugeable Preswaging Tool, Tube Fitting Installation

Fig. 1



Fig. 2



Fig. 3

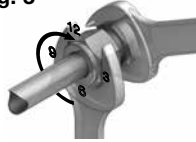

1. Insert the tube with preswaged ferrules into the fitting until the front ferrule seats against the fitting body; rotate the nut finger-tight (Fig. 1).
2. Mark the nut at the 6 o'clock position (Fig. 2).
3. While holding the fitting body steady, tighten the nut one-half turn to the 12 o'clock position (Fig. 3).

Note: If assembling fittings for high-pressure applications or high safety-factor systems (severe service), tighten one hex flat further than one-half turn.

Gaugeability

Fig. 4

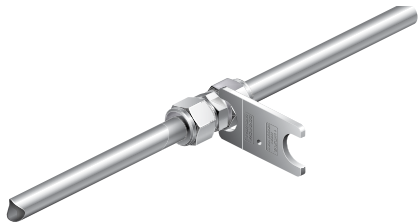

Fig. 5



On initial installation, the Swagelok gap inspection gauge assures the installer or inspector that a fitting has been sufficiently tightened.

If the nut was tightened additionally during installation (step 3), use Fig. 4 for gauging, otherwise use Fig. 5.

Position the Swagelok gap inspection gauge next to the gap between the nut and body.

- If the gauge will not enter the gap, the fitting is sufficiently tightened.
- If the gauge will enter the gap, additional tightening is required.

Bored-Through Fittings for Thermocouples, Dip Tubes, and Heat Exchanger Tees

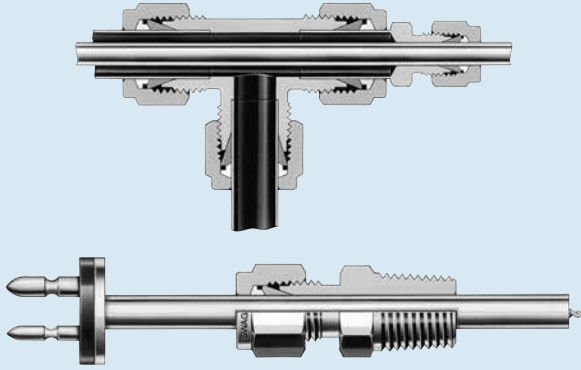

Swagelok bored-through male connectors accommodate thermocouples or dip tubes. Most male connectors are available as a bored-through fitting, but male connectors whose pipe thread end is small relative to the tube fitting end—such as **-600-1-2** or **-8M0-1-2RT**—cannot be bored through.

Swagelok bored-through reducers and standard Swagelok tees can be used to create a heat exchanger tee.

To order bored-through fittings, add **BT** to the ordering number. Example: SS-400-1-4**BT**

Bored-through fittings have a reduced pressure rating. In general, we have multiplied the allowable working pressure of the tubing, as found on the *Tubing Data Sheet*, MS-01-107, by the factors in the table to the right.

Reduced Pressure Rating Factors

Size (in.)	Size (mm)	Factor
Up to 1/2 in.	Up to 12 mm	0.75
Above 1/2 in. to 3/4 in.	Above 12 mm to 18 mm	0.50
Above 3/4 in.	Above 18 mm	0.25

Alloy 2507 Tubing



Swagelok offers Alloy 2507 tubing in sizes of 1/4 to 1 in. outside diameter. Refer to *Alloy 2507 Seamless Super Duplex Tubing—Fractional Sizes* catalog, MS-02-151, for additional information.

Alloy 2507 Weld Fittings

Refer to *Alloy 2507 Super Duplex Weld Fittings* catalog, MS-01-173, for additional information.



Tubing Tools and Accessories

For tube benders, wrenches, cutters, liquid leak detectors, and more, refer to *Tubing Tools and Accessories* catalog, MS-01-179, for additional information.



⚠ WARNING

Do not mix/interchange Swagelok products or components not governed by industrial design standards, including Swagelok tube fitting end connections, with those of other manufacturers.

Introduction

Since 1947, Swagelok has designed, developed, and manufactured high-quality, general-purpose and specialty fluid system products to meet the evolving needs of global industries. Our focus is on understanding our customers' needs, finding timely solutions, and adding value with our products and services.

We are pleased to provide this global edition of the book-bound *Swagelok Product Catalog*, which compiles more than 100 separate product catalogs, technical bulletins, and reference documents into one convenient, easy-to-use volume. Each product catalog is up to date at the time of printing, with its revision number shown on the last page of the individual catalog. Subsequent revisions will supersede the printed version and will be posted on the Swagelok website and in the Swagelok electronic Desktop Technical Reference (eDTR) tool.

For more information, visit your Swagelok website or contact your authorized Swagelok sales and service representative.

Warranty Information

Swagelok products are backed by The Swagelok Limited Lifetime Warranty. For a copy, visit swagelok.com or contact your authorized Swagelok representative.

Safe Product Selection

When selecting a product, the total system design must be considered to ensure safe, trouble-free performance. Function, material compatibility, adequate ratings, proper installation, operation, and maintenance are the responsibilities of the system designer and user.

WARNING

Do not mix/interchange Swagelok products or components not governed by industrial design standards, including Swagelok tube fitting end connections, with those of other manufacturers.

Not all trademarks listed below apply to this catalog.
Swagelok, Cajon, Ferrule-Pak, Goop, Hinging-Colleting, IGC, Kenmac, Micro-Fit, Nupro, Snoop, Sno-Trik, SWAK, VCO, VCR, Ultra-Torr, Whitey—TM Swagelok Company
15-7 PH—TM AK Steel Corp.
AccuTrak, Beacon, Westlock—TM Tyco International Services
Atlas—TM Asahi Glass Co., Ltd.
ASCO, El-O-Matic—TM Emerson
AutoCAD—TM Autodesk, Inc.
CSA—TM Canadian Standards Association
Crastin, DuPont, Kalrez, Krytox, Teflon, Viton—TM E.I. duPont Nemours and Company
DeviceNet—TM ODVA
Dyneon, Elgiloy, TFM—TM Dyneon
Elgiloy—TM Elgiloy Specialty Metals
FM—TM FM Global
Grafoil—TM GrafTech International Holdings, Inc.
Honeywell, MICRO SWITCH—TM Honeywell
MAC—TM MAC Valves
Microsoft, Windows—TM Microsoft Corp.
NACE—TM NACE International
PH 15-7 Mo, 17-7 PH—TM AK Steel Corp
picofast—Hans Turck KG
Pillar—TM Nippon Pillar Packing Company, Ltd.
Raychem—TM Tyco Electronics Corp.
Sandvik, SAF 2507—TM Sandvik AB
Simriz—TM Freudenberg-NOK
SolidWorks—TM SolidWorks Corporation
UL—Underwriters Laboratories Inc.
Xylan—TM Whitford Corporation
© 2021 Swagelok Company